

Bi-Spectrum Radiometric Detector User Manual

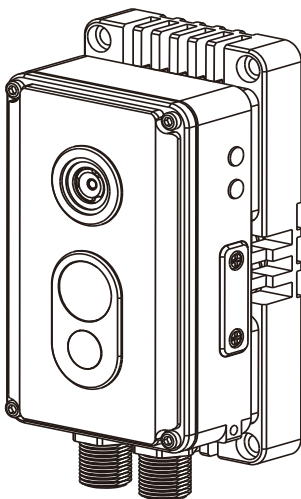

Issue

V 1.0

Date

2021-08-03





Precautions

Precautions

Fully understand this document before using this device, and strictly observe rules in this document when using this device. If you install this device in public places, provide the tip "You have entered the area of electronic surveillance" in an eye-catching place. Failure to correctly use electrical products may cause fire and severe injuries. To prevent accidents, carefully read the following context:

Symbols

This document may contain the following symbols whose meanings are described accordingly.

Symbol	Description
 DANGER	It alerts you to fatal dangers which, if not avoided, may cause deaths or severe injuries.
 WARNING	It alerts you to moderate dangers which, if not avoided, may cause minor or moderate injuries.
 CAUTION	It alerts you to risks. Neglect of these risks may cause device damage, data loss, device performance deterioration, or unpredictable results.
 TIP	It provides a tip that may help you resolve problems or save time.
 NOTE	It provides additional information.

DANGER

To prevent electric shocks or other dangers, keep power plugs dry and clean.

WARNING

- Strictly observe installation requirements when installing the device. The manufacturer shall not be held responsible for device damage caused by users' non-conformance to these requirements.
- Strictly conform to local electrical safety standards and use power adapters that are marked with the LPS standard when installing and using this device. Otherwise, this device may be damaged.

- Use accessories delivered with this device. The voltage must meet input voltage requirements for this device.
- If this device is installed in places with unsteady voltage, ground this device to discharge high energy such as electrical surges in order to prevent the power supply from burning out.
- When this device is in use, ensure that no water or any liquid flows into the device. If water or liquid unexpectedly flows into the device, immediately power off the device and disconnect all cables (such as power cables and network cables) from this device.
- Do not expose the thermal imaging camera or unpacked product to extremely strong radiation sources, such as the sun, laser, or arc welding machine, regardless of whether the device is being electrified or not; do not put the camera close to high thermal objects such as the sunlight; otherwise, the precision of the camera may be affected and even the detector inside the camera may suffer a permanent damage.
- If this device is installed in places where thunder and lightning frequently occur, ground the device nearby to discharge high energy such as thunder strikes in order to prevent device damage.

**CAUTION**

- Unless otherwise specified, do not use the camera in a temperature lower than -20 °C (-4 °F) or higher than +60 °C (+140 °F). Too-high or too-low temperature may cause image display anomaly of the camera and the camera will be damaged if it is working under such a condition for a long time.
- If the camera is installed outdoors, avoid direct sunlight at dawn and dusk on the camera lens and install a sunshield with frontal and rear positions adjusted according to the sunlight angle.
- Avoid heavy loads, intensive shakes, and soaking to prevent damages during transportation and storage. The warranty does not cover any device damage that is caused during secondary packaging and transportation after the original packaging is taken apart.
- Protect this device from fall-down and intensive strikes, keep the device away from magnetic field interference, and do not install the device in places with shaking surfaces or under shocks.
- Clean the device with a soft dry cloth. For stubborn dirt, dip the cloth into slight neutral cleanser, gently wipe the dirt with the cloth, and then dry the device.
- Since the camera lens is painted with a durable coating material, it adapts to outdoor environment. The lens must be cleaned regularly. If the image quality is reduced or excessive dirt is deposited on the lens, clean the lens in a timely manner. In sandy (in desert) or corrosive (on sea) environment, use the camera with caution; improper use may cause the coating to peel off.
- Do not jam the ventilation opening. Follow the installation instructions provided in this document when installing the device.
- Keep the device away from heat sources such as radiators, electric heaters, or other heat equipment.

- Keep the device away from moist, dusty, extremely hot or cold places, or places with strong electric radiation.
- If the device is installed outdoors, take insect- and moisture-proof measures to avoid circuit board corrosion that can affect monitoring.
- Remove the power plug if the device is idle for a long time.
- Before unpacking, check whether the fragile sticker is damaged. If the fragile sticker is damaged, contact customer services or sales personnel. The manufacturer shall not be held responsible for any artificial damage of the fragile sticker.

Special Announcement

All complete products sold by the manufacturer are delivered along with nameplates, operation instructions, and accessories after strict inspection. The manufacturer shall not be held responsible for counterfeit products.

This manual may contain misprints, technology information that is not accurate enough, or product function and operation description that is slightly inconsistent with the actual product. The manufacturer will update this manual according to product function enhancement or changes and regularly update the software and hardware described in this manual. Update information will be added to new versions of this manual without prior notice.

This manual is only for reference and does not ensure that the information is totally consistent with the actual product. For consistency, see the actual product.

Contents

Precautions	i
Contents	4
1 Overview	6
1.1 Principle of Thermal Imaging and Advantages	6
1.2 Product Introduction.....	7
1.2.1 Product Features.....	7
1.3 Description of Cable.....	7
1.3.1 Multi-cable.....	7
2 Device Dimensions	9
3 Device Installation	11
3.1 Cabinet Installation	11
3.1.1 General Installation.....	11
3.1.2 Magnet Installation.....	13
3.2 Wall Installation	14
3.2.1 Bracket Installation	14
3.2.2 Wall Installation	15
3.3 Packing list.....	16
4 Quick Configuration	18
4.1 Login and Logout	18
4.2 Main Page Layout	19
4.3 Change the Password.....	21
4.4 Browse Video	22
4.5 Install Plugins.....	24
4.5.1 Set Local Network Parameters	24
4.6 Thermal Settings	27
4.6.1 Temperature Parameters	27
4.6.2 Ambient Temperature	31
4.6.3 Temperature Area	32
4.6.4 Shield Area.....	36
4.6.5 Schedule Linkage	37
4.6.6 Thermal Mapping.....	39
4.6.7 Bad Point Check.....	40

4.6.8 LED Control Parameter.....	42
5 Thermal Parameter Configuration.....	45
5.1 Access the Sensor Setting Interface.....	45
5.2 Sensor Setting Parameter description.....	46
5.2.1 Mode.....	46
5.2.2 Image Setting.....	47
5.2.3 Scene.....	48
5.2.4 Set Pseudocolor.....	49
5.2.5 FFC Control.....	50
5.2.6 Noise Reduction.....	52
5.2.7 Enhance Image.....	53
6 Visible-light Parameter Configuration.....	55
6.1 Access the Sensor Interface.....	55
6.2 Sensor Setting Parameter description.....	56
6.2.1 Mode.....	56
6.2.2 Image Adjust.....	57
6.2.3 Scene Mode.....	59
6.2.4 Exposure.....	60
6.2.5 WB Setting.....	61
6.2.6 Daynight.....	63
6.2.7 Noise Reduction.....	65
6.2.8 Enhance Image.....	67
7 Camera Maintenance.....	69
A Common Emission Rate.....	70

1 Overview

1.1 Principle of Thermal Imaging and Advantages

Any object with temperature higher than the absolute zero (-273.15°C) will emit infrared (IR) ray, even though it does not emit light. The IR ray is also called thermal radiation. IR rays emitted by objects with different temperatures can be absorbed by the detector to reflect temperature change and thus generate an electric effect. The electric signal is amplified and processed to produce a thermal image that corresponds to the thermal distribution of the object surface. This is the process of thermal imaging.

- Adapt to any environment

Traditional cameras rely on natural or environmental light to shoot images, but this IR thermal imaging camera relies on the IR energy radiated by an object itself to form an image, not requiring any light. The IR thermal imaging camera is applicable to any environment and not affected by light strength. It can detect and identify any camouflage and concealed object both in daytime or nighttime, implementing round-the-clock monitoring.

- Monitor the temperature field with object energy distributed

The IR thermal imaging camera can show the temperature field of an object, converting the invisible surface temperature distribution situation to a visible thermal image that reflects the surface temperature distribution situation of the object. By this monitoring, users can discover temperature anomaly in a timely manner and take precautionary measures to avoid any risk that may be caused by the anomaly, for example, a fire.

- Boast cloud penetration capability

Visible light and near IR ray will be absorbed by the air, cloud and smoke, but they are transparent to IR ray of the 3~5 μm Medium Wavelength Infrared (MWIR) region and 8~14 μm Long Wavelength Infrared (LWIR) region. Traditional cameras cannot shoot clear images under cloudy environment, but the IR thermal imaging camera can penetrate the cloud and smoke to shoot clear images.

- Bi-Spectrum Radiometric Detector

"Temperature warning type thermal imaging camera + HD visible light" binocular monitoring.

Compact, lightweight, compact and cost effective.

Support horizontal/vertical installation.

1.2 Product Introduction

Bi-Spectrum Radiometric Detector, the whole machine shell and the base are all made of high strength aluminum alloy material with comprehensive function and high stability. It can be widely used in power switch cabinets, machine rooms, storages, etc.

1.2.1 Product Features

- Support network interface.
- The network transmission signal is up to 100 Mbps.
- Supports RS485/RS232 protocols.
- Suitable for power switch cabinets, computers room, store houses, etc.

1.3 Description of Cable

1.3.1 Multi-cable

Aviation power supply and network cable is shown as Figure 1-1, and the description is shown in Table 1-1.

Figure 1-1 Aviation power supply and network cable

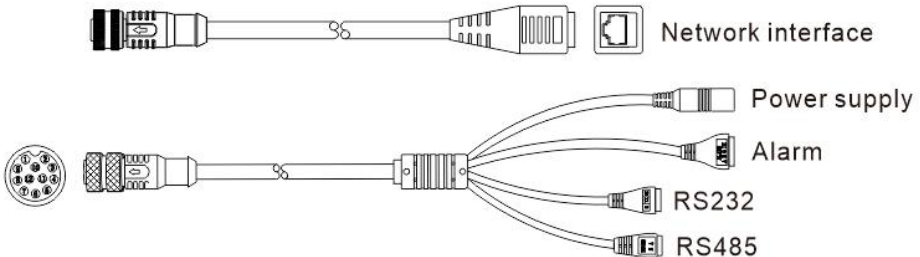

Table 1-1 Description of cores

Name	Port	Description
Network interface	-	Connect to a standard Ethernet cable
Power supply	-	Connect to DC 12 V
Alarm	A	ALARM OUT COM
	B	ALARM OUT
	G	ALARM IN COM

Name	Port	Description
	IN	ALARM IN
RS232	G	RS232 COM
	TX	RS232 TX
	RX	RS232 RX
RS485	A	RS485+
	B	RS485-

Figure 1-2 Panel interface

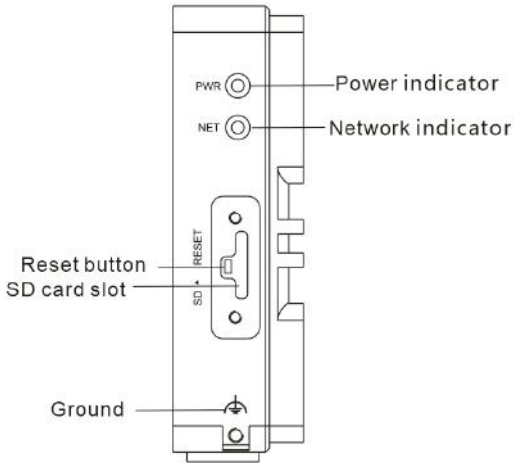

Table 1-2 Description of panel interface

Name	Description
Power indicator	When camera is power on, the light is steady on
Network indicator	Indicator flashes when the networking is working normally.
Reset button	Long press the reset button 5 seconds to restore to the original settings.
SD card slot	Support SD card
Ground	GND

2 Device Dimensions

Figure 2-1 shows the dimensions of the Bi-Spectrum Radiometric Detector.

Figure 2-1 Dimensions (unit: mm)

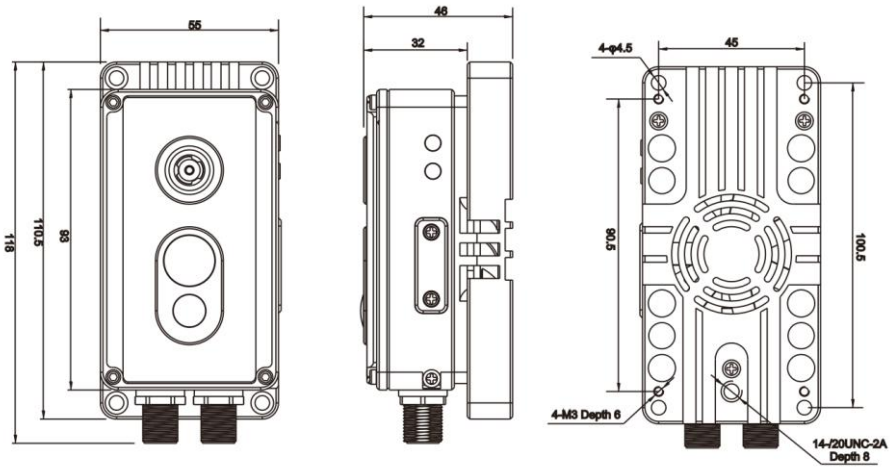

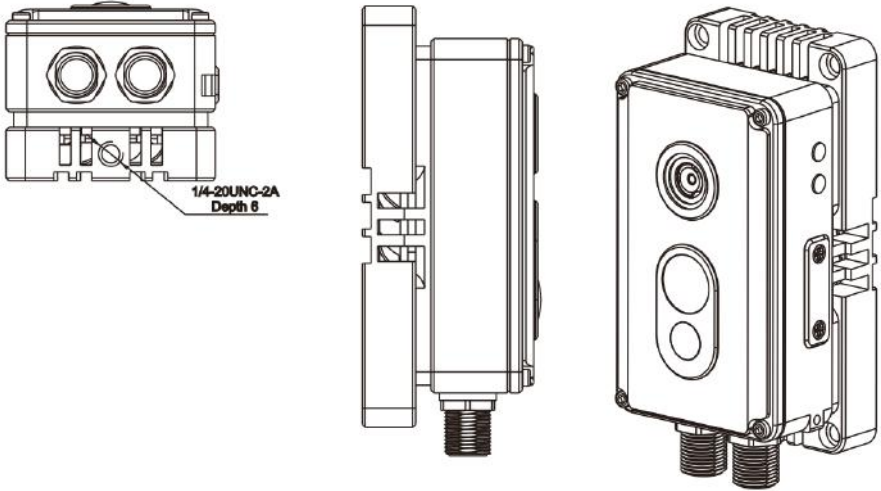

3 Device Installation

3.1 Cabinet Installation

3.1.1 General Installation

Step 1 Stick the installation sticker label 1 on the cabinet door 's mounting surface, drill three holes based on the marks on the sticker, as shown in Figure 3-1. It is recommended that the drill size be $\varphi 3 - \varphi 4$ mm, and it is better to remove the label after the hole is completed to avoid affecting heat dissipation.

Figure 3-1 Stick the sticker

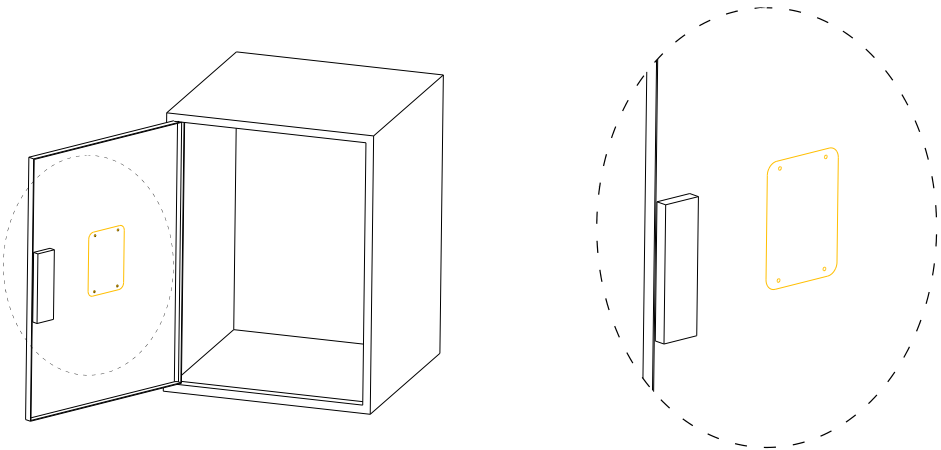

Step 2 Take out the camera and attach the camera to the holes which corresponding step 1 on the back of the cabinet door, as shown in Figure 3-2.

Figure 3-2 Attach the device

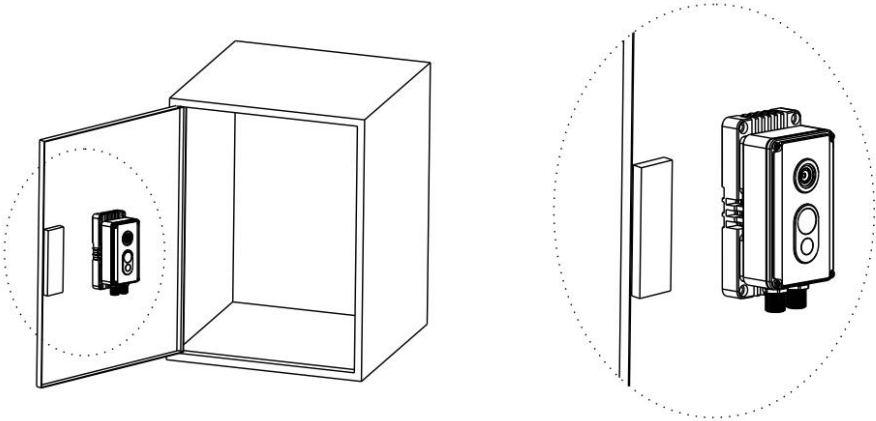

Step 3 Take out the PWM3×6 screws in the accessory and fix them on the screw holes of the camera through the holes punched in step 1 on the front of the door and tighten the screws.

Figure 3-3 Install the device

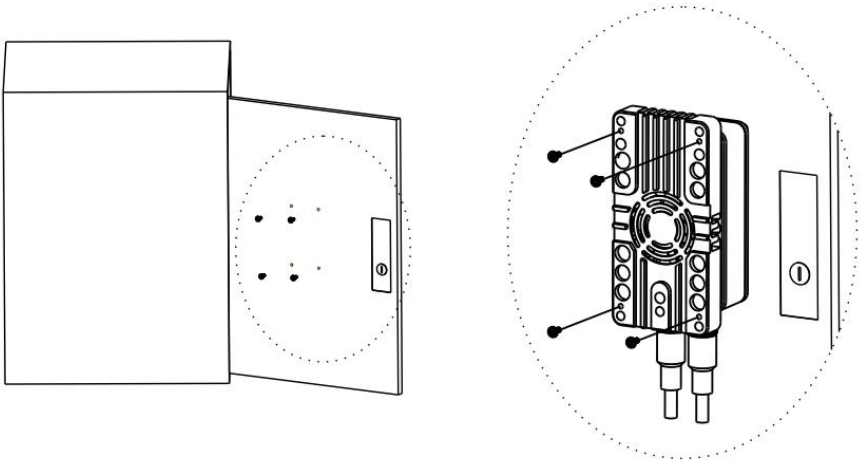

Step 4 Connect the multi-connector cable, start up the device.

----End

3.1.2 Magnet Installation

If you can't drill the hole in the door or the camera position needs precise adjustment, you can attach the magnet bracket to cabinet directly.

Step 1 Take out the camera, install the camera on cabinet, as shown in Figure 3-4.

Figure 3-4 Install the magnet bracket

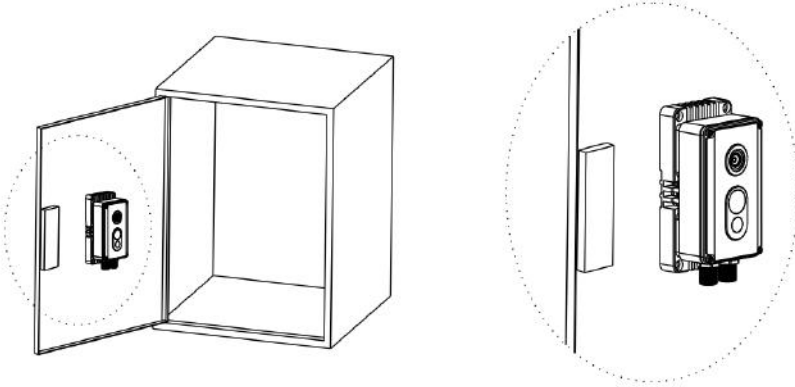

Step 2 Connect the multi-head combination cable to start up the camera, as shown in Figure 3-5.

Figure 3-5 Fixed the magnet bracket

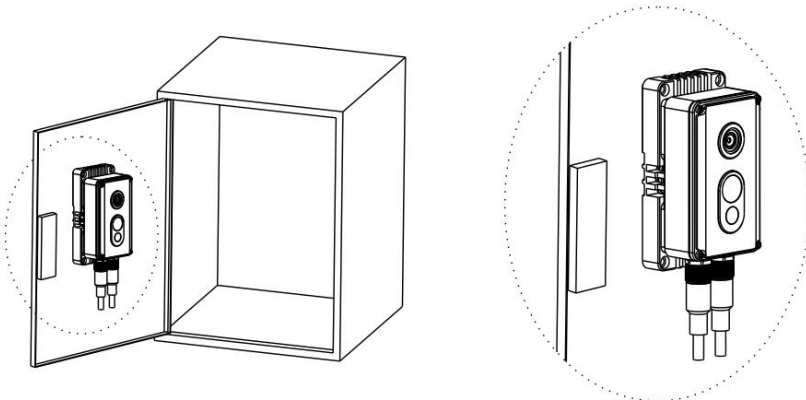

Step 3 Combine with the image of live video to move the camera to appropriate location.

----End

3.2 Wall Installation

3.2.1 Bracket Installation

If the camera angle needs to be adjusted, you need to use the gimbal bracket.

- Step 1 Stick the installation sticker label 3 on the walling 's mounting surface, drill three holes based on the marks on the sticker, drive three swell plastic buttons into the holes.
- Step 2 Take out the gimbal bracket, align the three through holes at the bottom of the bracket with the expansion rubber, and fix the bracket with the self-tapping screws in the accessory, as shown in Figure 3-6.

Figure 3-6 Install the gimbal bracket

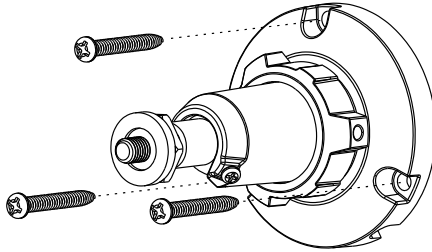

- Step 3 Take out the camera, align the 1/4 UNC hole on the back of the camera to the bracket screw, and then tighten the bracket nut, as shown in Figure 3-7.

Figure 3-7 Install the bracket

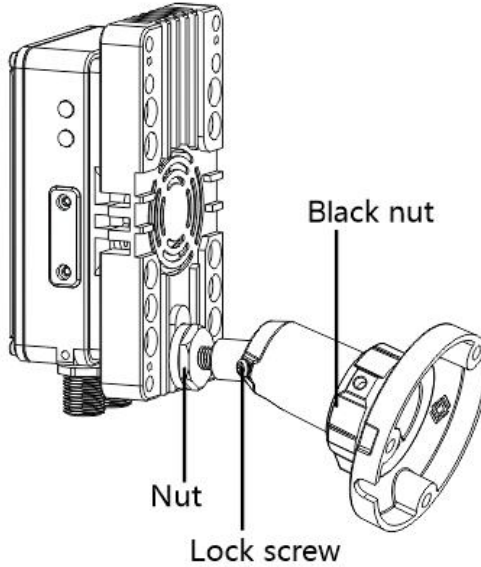

Step 4 Connect the multi-head combination cable to start up the camera.

Step 5 Adjust the universal rod of the bracket to adjust the camera angle, tighten the bottom bracket nut and tighten the locking screw on the bracket to complete the angle adjustment.

---End

3.2.2 Wall Installation

Step 1 Open the label 2 in the positioning label and attach it to the mounting position on the wall. Drill the hole in the small round hole of the positioning label with the drill bit and insert the expansion rubber into the hole.

Step 2 Attach the camera assembly to the sticker position and remove the self-tapping screws to secure the camera assembly, as shown in Figure 3-8.

Figure 3-8 Install camera

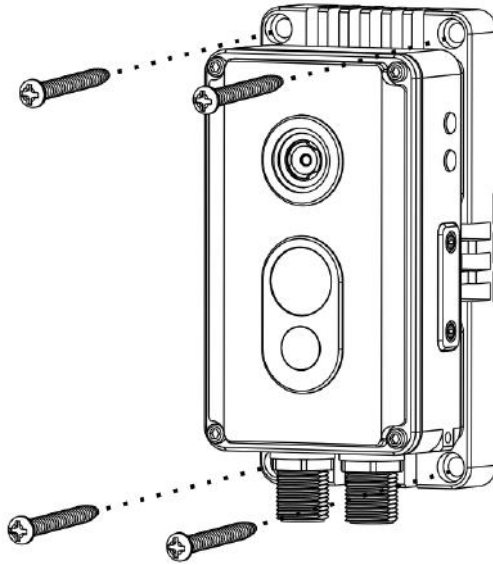

Step 3 Connect the multi-head combination cable to start up the camera.

----End

3.3 Packing list

After receiving the equipment, please follow the list of packing list to check, if there is any omission, please contact the seller.

Table 3-1 Packing list

No.	Item	Quantity	Picture
1	Camera	1	
2	Power supply and cable	1	
3	User manual	1	
4	Installation location sticker	1	
5	Screws PWM 3*6	4	

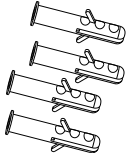
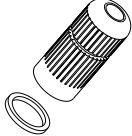
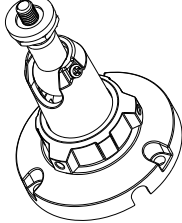
6	Self-tapping screw PT4*40	4	
7	Swell plastic button	4	
8	Network access port protective cover and waterproof rubber seal	1	
9	Gimbal bracket(Optional)	1	

4 Quick Configuration

4.1 Login and Logout



CAUTION

You must use Internet Explorer 8 or a later version to access the web management system; otherwise, some functions may be unavailable.

Login system

Step 1 Open the Internet Explorer, enter the IP address of IP camera (default value: 192.168.0.121) in the address box, and press Enter.

The login page is displayed, as shown in Figure 4-1.

Figure 4-1 Login page



Step 2 Input the User name and password.

NOTE

- The default user name is **admin**. The default password is **admin**. Change the password when you login the system for first time to ensure system security.
- You can change the system display language on the login page.

Step 3 Click Login.

The main page is displayed.

----End

Logout

To logout of system, click  in the upper right corner of the main page, the login page is display after you log out of the system.



4.2 Main Page Layout

On the main page, you can view live video, set parameters of configuration, play back recording, modify password, log out current user. Figure 4-2 is shown the main page layout. Table 4-1 lists the elements on the main page layout. Switch channel to show light video or thermal video.

Figure 4-2 Main page layout



Table 4-1 Elements on the main page

No.	Element	Description
1	Real-time video area	Real-time videos are played in this area. You can also set sensor parameters.
2	Playback	You can query the playback videos in this area. NOTE Only when the SD card has videos that user can query the playback videos.
3	Device configuration	You can choose a menu to set device parameters, including the device information, audio and video streams, alarm setting, and privacy mask function.
4	Change password	You can click  to change the password.
5	Sign Out	You can click  to return to the login page.
6	Stream	Choose the channel (visual channel or thermal channel) by clicking the image. There are four streams in channel 1,

No.	Element	Description
		there are two streams in channel 2. Choose one type from drop-down list.
7	PTZ	Control the external device which is communicated by RS 485 protocol, such as PTZ, high speed dome.
8	Pause/Start	Close live video or play live video.
9	Live/Smooth	Switch image quality.
10	Sensor setting	Click the icon, it will access to sensor setting.
11	Snapshot	Click the icon, it will snapshot.
12	Local record	Click the icon, it will record video and save.

 **NOTE**





1. When the device generates an alarm, the alarm icon  is displayed. You can click  to view the alarm information. When the device accepts an alarm signal, the alarm icon will display within 10 s in the web management system.
2. When the device encounters an exception, the fault icon  is displayed. You can click  to view the fault information.

Figure 4-3 Thermal channel live video



: the lowest temperature of the full screen.



: the highest temperature of the full screen.



: the lowest temperature of the area.



: the highest temperature of the area.

----End

4.3 Change the Password

Description

You can click  to change the password for logging in to the system.

Procedure

Step 1 Click  in the upper right corner of the main page.

The **Change Password** dialog box is displayed, as shown in Figure 4-4.

Figure 4-4 Modify Password dialog box

Change Password X

Old Password

New Password

Confirm

Password Advice:
1. Advice the password length of eight characters.
2. Advice the password includes numbers, capital letters, lowercase letters and special characters.
3. Advice the password can not be the same as username.

OK Cancel

 **NOTE**

The change password page will be displayed if you don't change the default password when you login to the system for the first time.

Step 2 Enter the old password, new password, and confirmation password.

Step 3 Click **OK**.

If the message "Change own password success" is displayed, the password is successfully changed. If the password fails to be changed, the cause is displayed. (For example, the new password length couldn't be less than eight.)

Step 4 Click **OK**.

The login page is displayed.

----End

4.4 Browse Video

User can browse the real-time video in the web management system.

Preparation

To ensure the real-time video can be displayed properly, you must perform the following operations when you login to the web for the first time:

Step 1 Open the Internet Explorer. **Choose Tools > Internet options > Security > Trusted sites > Sites.**

In the display dialog box, click **Add**, as shown in Figure 4-5.

Figure 4-5 Adding the a trusted site

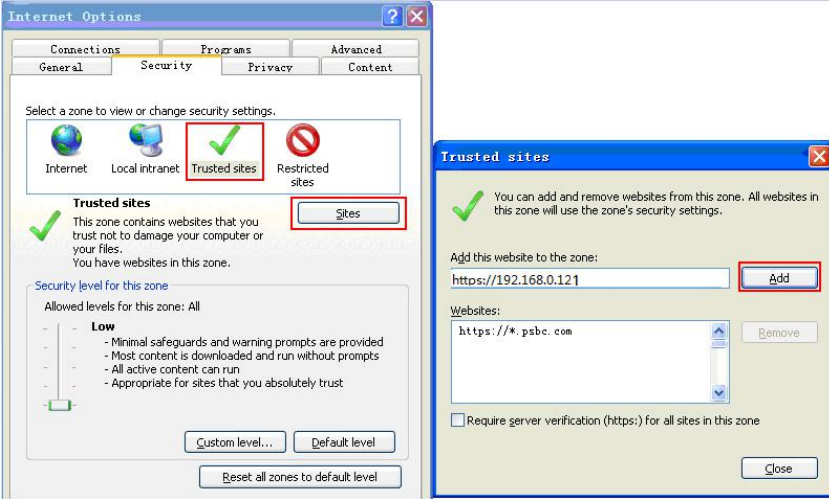

Step 2 In the Internet Explorer, choose **Tool > Internet Options > Security > Customer level**, and set **Download unsigned ActiveX control and initialize and script ActiveX controls not marked as safe for scripting under ActiveX controls and plug-ins** to **Enable**, as shown in Figure 4-6.

Figure 4-6 Configuring ActiveX control and plug-ins

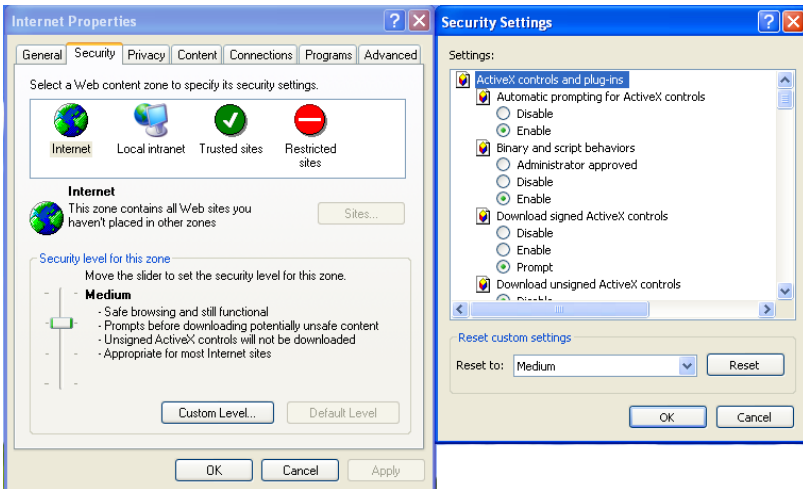

Step 3 Download and install the player control as prompted.

NOTE

The login page is display when the control is loaded.

4.5 Install Plugins

You will be prompted with a message “Download and install the new plugin” as shown in Figure 4-7 when you login to the web management system for the first time.

Figure 4-7 Download the plugin page

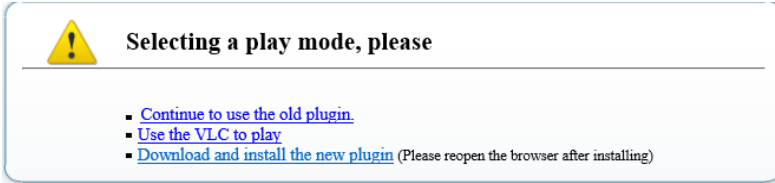

Procedure

Step 1 Click the message, download and install the plugin follow the prompts.

Step 2 Reopen the browser after installation.

Step 3 Click [Switch to VLC, then play the video](#) [Switch to Plugin, then play the video](#) to switch the plugin.

----End

4.5.1 Set Local Network Parameters

Description

Local network parameters include:

- IP protocol
- IP address
- Subnet mask
- Default gateway
- Dynamic Host Configuration Protocol (DHCP)
- Preferred Domain Name System (DNS) server
- Alternate DNS server
- MTU

Procedure

Step 1 Choose **Configuration > Device > Local Network**.

The **Local Network** page is displayed, as shown in Figure 4-8.

Figure 4-8 Local Network page

Step 2 Set the parameters according to Table 4-2.

Table 4-2 Local network parameters

Parameter	Description	Setting
IP Protocol	IP v 4 is the IP protocol that uses an address length of 32 bits.	[Setting method] Select a value from the drop-down list box. [Default value] IPv4
DHCP	The device automatically obtains the IP address from the DHCP server.	[Setting method] Click the option button. NOTE To query the current IP address of the device, you must query it on the platform based on the device name.
DHCP IP	IP address that the DHCP server assigned to the device.	N/A
IP Address	Device IP address that can be set as required.	[Setting method] Enter a value manually. [Default value] 192.168.0.121

Parameter	Description	Setting
Subnet Mask	Subnet mask of the network adapter.	[Setting method] Enter a value manually. [Default value] 255.255.255.0
Default Gateway	This parameter must be set if the client accesses the device through a gateway.	[Setting method] Enter a value manually. [Default value] 192.168.0.1
Preferred DNS Server	IP address of a DNS server.	[Setting method] Enter a value manually. [Default value] 192.168.0.1
Alternate DNS Server	IP address of a domain server. If the preferred DNS server is faulty, the device uses the alternate DNS server to resolve domain names.	[Setting method] Enter a value manually. [Default value] 192.168.0.2
MTU	Set the maximum value of network transmission data packets.	[Setting method] Enter a value manually. NOTE The MTU value is range from 800 to 1500, the default value is 1500, Please do not change it arbitrarily.

Step 3 Click **OK**.

- If the message "Apply success" is displayed, click **OK**. The system saves the settings. The message "Set network param's success, Please login system again" is displayed. Use the new IP address to login to the web management system.
- If the message "Invalid IP Address", "Invalid Subnet Mask", "Invalid default gateway", "Invalid primary DNS", or "Invalid space DNS" is displayed, set the parameters correctly.

 **NOTE**

- If you set only the **Subnet Mask**, **Default Gateway**, **Preferred DNS Server**, and **Alternate DNS Server** parameters, you do not need to login to the system again.
- You can click **Reset** to set the parameters again if required.

----End

4.6 Thermal Settings

4.6.1 Temperature Parameters

Temperature parameters include: temperature unit, length units, cavity temperature, correction coefficient and area temperature display mode, etc.

Operation Procedure

Step 1 Choose **Configuration >Thermal >Temperature Parameters**.

The **Temperature Parameters** page is displayed, as shown in Figure 4-9.

Figure 4-9 Temperature Parameters interface

Temperature Parameters

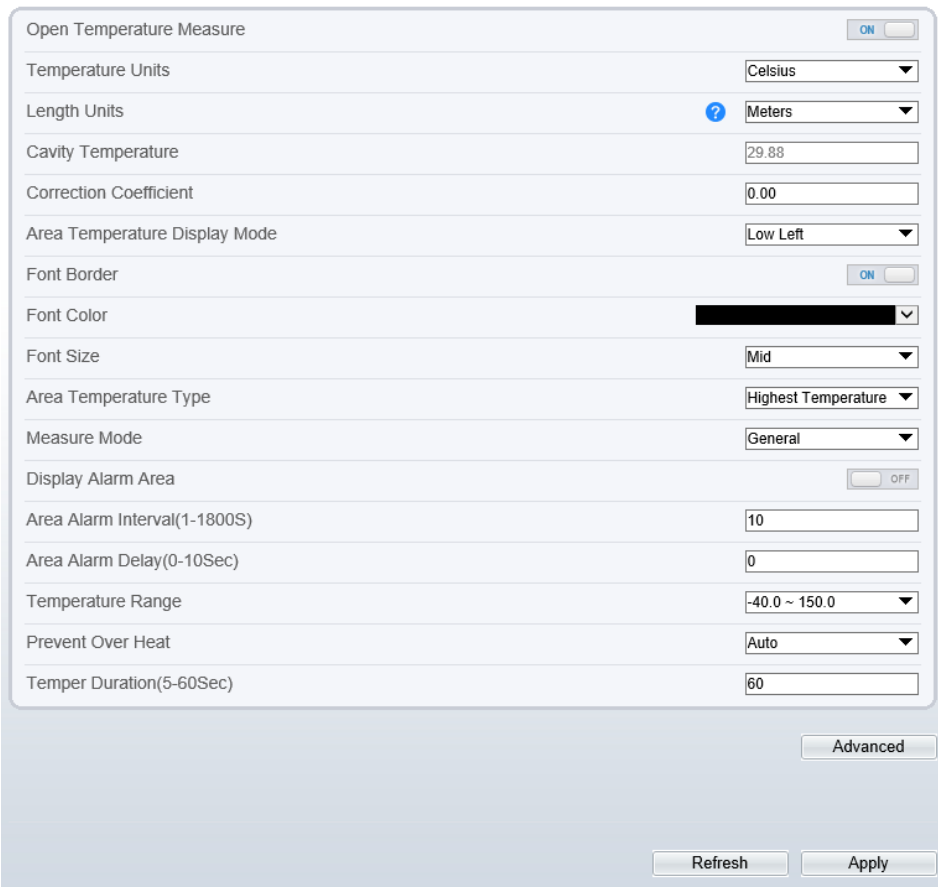

Open Temperature Measure	<input type="checkbox"/> ON <input type="checkbox"/> OFF
Temperature Units	Celsius
Length Units	Meters
Cavity Temperature	29.88
Correction Coefficient	0.00
Area Temperature Display Mode	Low Left
Font Border	<input type="checkbox"/> ON <input type="checkbox"/> OFF
Font Color	Black
Font Size	Mid
Area Temperature Type	Highest Temperature
Measure Mode	General
Display Alarm Area	<input type="checkbox"/> OFF
Area Alarm Interval(1-1800S)	10
Area Alarm Delay(0-10Sec)	0
Temperature Range	-40.0 ~ 150.0
Prevent Over Heat	Auto
Temper Duration(5-60Sec)	60

Advanced

Refresh Apply

Step 2 Set the parameters according to Table 4-3.

Table 4-3 Temperature parameters

Parameter	Description	Setting
Temperature Unit	Celsius and Fahrenheit temperature units are available.	[Setting method] Select a value from the drop-down list box. [Default value] Celsius
Length Unit	Meter and Inch units are available..	[Setting method] Select a value from the drop-down list box. [Default value] Meters
Cavity Temperature	The cavity temperature of camera.	N/A
Correction Coefficient	Correction coefficient is refer to the deviation of measured object temperature and actual temperature. For example: 1. The measured object temperature is 30, and actual temperature is 37, so the correction coefficient should be 7 . 2. The measured object temperature is 37, and actual temperature is 30, so the correction coefficient should be -7 .	[Setting method] Enter a value manually. [Default value] 0.00
Area Temperature Display Mode	The display position of temperature information on the live-video image.	[Setting method] Select a value from the drop-down list box. [Default value] Low left
Font Border	Enable to bold the font	[Setting method] Enable or disable [Default value] Disable
Font Color/Font Size	Set the font's color and size, there are nine colors chosen.	[Setting method] Select a value from the drop-down list box. [Default value] Black /Mid

Parameter	Description	Setting
Area Temperature Type	There are three types of area temperature.	[Setting method] Select a value from the drop-down list box. [Default value] Highest Temperature
Measure Mode	There are two types measure modes.	[Setting method] Select a value from the drop-down list box. [Default value] General
Display Alarm Area	N/A	[Setting method] Enable or disable [Default value] Disable
Area Alarm Interval	N/A	[Setting method] Enter a value manually ranges from 1 to 1800. [Default value] 10
Temperature range	It depends the device, different devices have different modes, there are two ranges, such as -20 °C -150°C, -40 °C-150°C.	[Setting method] Select a value from the drop-down list box.
Prevent Over Heat	Open, if temperature of the testing area is too high, you can enable prevent over heat function, there are two types, manual and auto.	[Setting method] Select a value from the drop-down list box.
Temper Duration(5-60 S)	Prevent over heat' mode is auto, the control cover will block for duration time automatically if over heat.	[Setting method] Enter a value manually ranges from 5 to 60.
Control Cover	When prevent over heat mode is manual, the user should choose the action manually, such as pick up, lay down.	[Setting method] Select a value from the drop-down list box.

Figure 4-10 Advanced interface

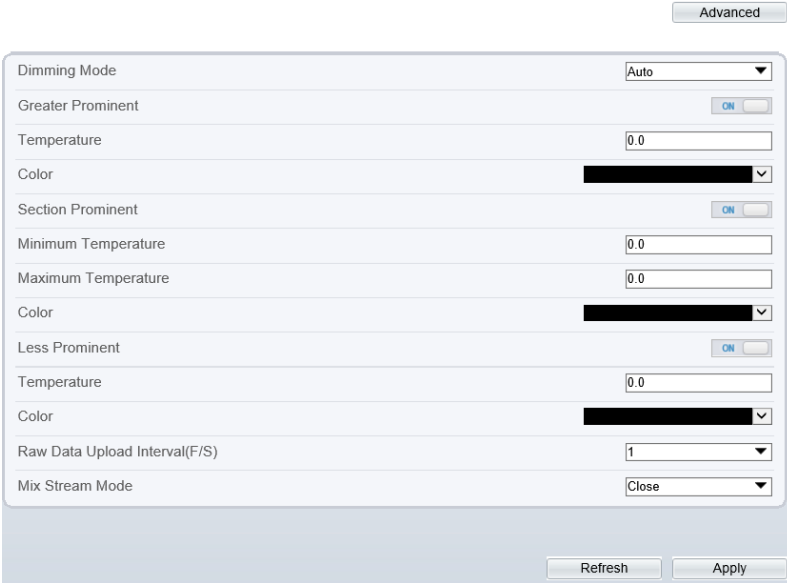

Table 4-4 Advance parameters

Parameter	Description	Setting
Dimming Mode	There are auto and manual modes. It will show on temperature item.	[Setting method] Select a value from the drop-down list box. [Default value] Auto
Greater Prominent	Enable that, the image will show the setting color if the temperature is higher than set value.	[Setting method] Enter a value manually. Choose one color to show.
Section Prominent	Enable that, the image will show the setting color if the temperature is between minimum and maximum temperature.	[Setting method] Enter a value manually. Choose one color to show.
Less Prominent	Enable that, the image will show the setting color if the temperature is lower than set value.	[Setting method] Enter a value manually. Choose one color to show.

Parameter	Description	Setting
Raw Data Upload Interval(F/S)	Interval of Upload the raw data.	[Setting method] Select a value from the drop-down list box. [Default value] 1
Mix Stream Mode	This function is used for thermal and visible lighting image to mix. There are close, mode 1, mode 2 and mode 3.	[Default value] Close

Step 3 Click **Apply**.

The message "Apply success" is displayed, the system saves the settings.

----End

4.6.2 Ambient Temperature

Set the ambient temperature of camera, click "Apply" to save the setting, click "Refresh" the adaptation environment temperature will be refresh based on ambient temperature.

Figure 4-11 Ambient temperature

Ambient Temperature

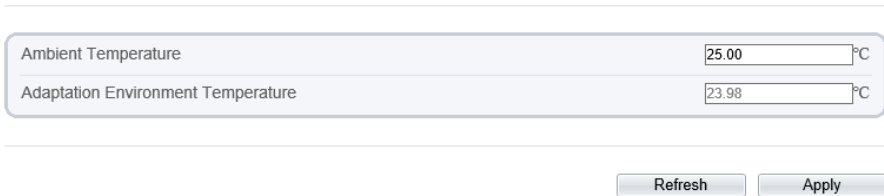

Ambient Temperature °C

Adaptation Environment Temperature °C

Table 4-5 parameter of ambient temperature

Parameter	Description	Setting
Ambient Temperature	Environment temperature of camera.	[Setting method] Enter the temperature of ambient. [Default value] 25
Adaptation environment temperature	Set the ambient temperature, click "Apply", click "Refresh", the camera will get the value automatically.	---

----End

4.6.3 Temperature Area

Operation Procedure

Step 1 Choose **Configuration >Thermal >Temperature Area.**

The **Temperature Area** page is displayed, as shown in Figure 4-12

Figure 4-12 Temperature area and alarm configuration

☰ Temperature Area And Alarm Configuration

Channel 2
Measure Mode General

2021-03-19 23:13:43 Fri

— + 6

[*] [##] [] [] A []

Enable	ID	Name	Type	Alarm Type	Warning Value	Alarm Value	Maximum Alarm Va	Duration(1-1)
<input checked="" type="checkbox"/>	0	Area0	Rectangle	Threshold Alarm	48.00	50.00	60.00	1.00
<input type="checkbox"/>	1	Area1	Point	Threshold Alarm	48.00	50.00	60.00	1.00
<input type="checkbox"/>	2	Area2	Point	Threshold Alarm	48.00	50.00	60.00	1.00
<input type="checkbox"/>	3	Area3	Point	Threshold Alarm	48.00	50.00	60.00	1.00
<input type="checkbox"/>	4	Area4	Point	Threshold Alarm	48.00	50.00	60.00	1.00
<input type="checkbox"/>	5	Area5	Point	Threshold Alarm	48.00	50.00	60.00	1.00
<input type="checkbox"/>	5	Area5	Point	Threshold Alarm	48.00	50.00	60.00	1.00
<input type="checkbox"/>	6	Area6	Point	Threshold Alarm	48.00	50.00	60.00	1.00
<input type="checkbox"/>	7	Area7	Point	Threshold Alarm	48.00	50.00	60.00	1.00

Refresh Apply

Step 2 Set the parameters according to Table 4-6

Table 4-6 Temperature area and alarm configuration

Parameter	Description	Setting
Channel	N/A	[Setting method] Select a value from the drop-down list box. [Default value] 1
Measure Mode	Set at temperature parameters interface.	N/A
Name	Area name of temperature area.	[Setting method] Enter a value manually.
Type	Type of temperature area. ID 0 is default rectangle area, which is full screen.	[Setting method] Select a value from the drop-down list box. [Default value] Rectangle/Point
Alarm Type	Threshold alarm, temperature difference alarm, section alarm, temperature rise alarm are available for alarm type. Section Alarm: if the temperature value is among the set temperature range, it will generate the alarm. Temperature rise alarm means it the rising temperature value is more than the set value, it will generate the alarm. It need to set the alarm schedule	[Setting method] Select a value from the drop-down list box. [Default value] Threshold alarm
Warning Value	Camera will trigger warning alarm when the object temperature reaches the warning value.	[Setting method] Enter a value manually. [Default value] 48
Alarm Value	Camera will alarm when the object temperature reaches the alarm value.	[Setting method] Enter a value manually. [Default value] 50
Maximum Alarm Value	At section alarm type, the device would not alarm when the temperature is higher than maximum alarm value.	[Setting method] Enter a value manually. [Default value] 60.00

Parameter	Description	Setting
Duration (1-10S)	Choose temperature rise alarm, set the duration, the temperature rise the value and it is keep for duration setting, the alarm is triggered successfully.	
Emission Rate	The emission rate is the capability of an object to emit or absorb energy. The emission rate should be set only when the target is special material.	[Setting method] Enter a value manually. [Default value] 0.95
Distance(M)	The distance between camera and target.	[Setting method] Enter a value manually. [Default value] 15  NOTE Enter actual distance when the distance between camera and target is less than 15m. Enter 15 when the distance between camera and target is great than or equal to 15m.
Alarm	Enable or disable the alarm output and linkage of area.	[Setting method] Tick the alarm output channel .

Parameter	Description	Setting
Group ID	<p>The ID can be chosen into one of six groups, or no group. The group will be alarm following as the next rules:</p> <p>A=The highest temperature of groups (the highest temperature of N regions is the largest)</p> <p>B=Average temperature of groups (average temperature of N regions)</p> <p>WA=Warning value</p> <p>AA=Alarm value</p> <p>a. If $A-B \geq WA$, a temperature difference warning signal is generated ---> (the one with the largest difference between the N areas and the average temperature is the alarm area flashing)</p> <p>b. If $A-B \geq AA$, a temperature difference alarm signal is generated ---> (the one with the largest difference between the N areas and the average temperature is the alarm area flashing)</p> <p>c. If the warning and alarm conditions are met at the same time, the alarm signal will be generated first.</p>	<p>[Setting method]</p> <p>Select a value from the drop-down list box.</p>

Step 3 Set temperature area.

1. Tick an area ID.
2. Select type from drop-list.
3. Press and hold the left mouse button, and drag in the video area to create a temperature area, as shown in Figure 4-13. Right-click to finish the area selected.

Figure 4-13 Temperature Area Setting Interface



4. Click **Apply**, the message “Apply success” is displayed, the temperature area is set successfully.

Delete a temperature area:

1. Select an area ID.
2. Click the temperature area and right-click.
3. Remove the tick of area ID.
4. Click **Apply**, the message “Apply success” is displayed, the temperature area is deleted successfully.

Step 4 Click **Apply**.

The message "Apply success" is displayed, the system saves the settings.

----End

4.6.4 Shield Area

Shield area is meaning that the camera will not to detect the temperature of that area.

Operation Procedure

Step 1 Choose **Configuration > Thermal > Shield Area**.

Figure 4-14 Shield Area

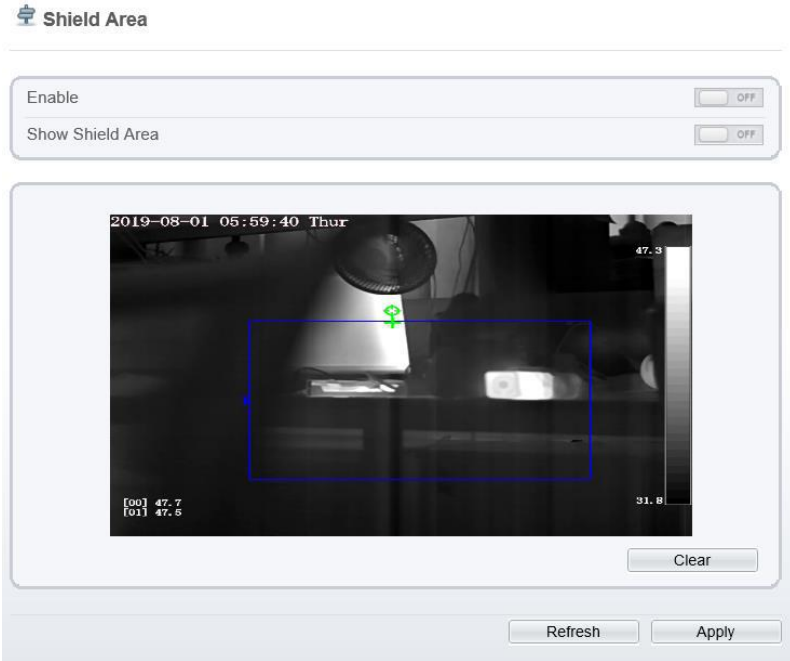

- Step 2 Enable the shield area.
 - Step 3 Enable **Show Shield Area**, then the setting shield will show in live video.
 - Step 4 Click left mouse button to set area, click right mouse button to end the setting.
 - Step 5 Click **Clear** to clear the shield area.
- End

4.6.5 Schedule Linkage

Operation Procedure

- Step 1 Choose **Configuration > Thermal > Schedule Linkage**
The **Schedule Linkage** page is displayed, as shown in Figure 4-15.

Figure 4-15 Schedule Linkage

 **Schedule Linkage**

Threshold Alarm Threshold Warning Temperature Differenc Temperature Differenc Temperature Section /
Temperature Rise Alai Temperature Rise Wa

Output Channel

Alarm Record OFF

SMTP OFF

FTP Upload OFF

	0	1	2	3	4	5	6	7	8	9	10	11	12	13	14	15	16	17	18	19	20	21	22	23	24
Sun																									
Mon																									
Tues																									
Wed																									
Thur																									
Fri																									
Sat																									

- Step 2 Tick the output channel.
- Step 3 Enable “Alarm Record”, “SMTP”, ”FTP” button.
- Step 4 Set schedule linkage.

Method 1: Click left mouse button to select any time point within 0:00-24:00 from Monday to Sunday as shown in Figure 4-15.

Method 2: Hold down the left mouse button, drag and release mouse to select the alarm time within 0:00-24:00 from Sunday to Saturday.

 **NOTE**

When you select time by dragging the cursor, the cursor cannot be moved out of the time area. Otherwise, no time can be selected.

Method 3: Click  in the alarm time page to select the whole day or whole week.

Deleting alarm time: Click  again or inverse selection to delete the selected alarm time.

- Step 5 Click **Apply**.

The message "Apply success" is displayed, the system saves the settings.

----End

4.6.6 Thermal Mapping

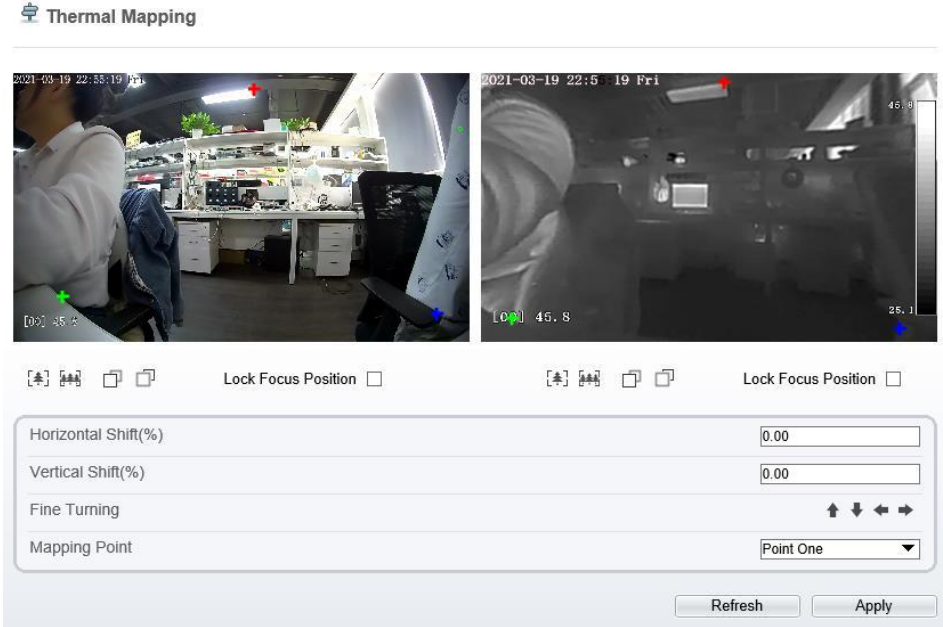

Step 1 Choose **Configuration >Thermal Mapping**, as shown in Figure 4-16.

Figure 4-16 Thermal mapping interface



Step 2 Settings please refer to Table 4-7.

Table 4-7 Parameter of thermal mapping

Parameter	Description	Setting
	Zoom in /zoom out.	[Setting method] Click the button
	Near focus / far focus.	[Setting method] Click the button
Lock focus position	N/A	[Setting method] Tick .
Horizontal shift(%)	Input the value, the area of setting will be move horizontal the correspond location. The result will be shown on visual channel.	

Parameter	Description	Setting
vertical shift(%)	Input the value, the area of setting will be move vertical the correspond location. The result will be shown on visual channel.	
Fine turning	Click the icon to move the area of setting.	
Mapping point	You need map three points at two channels. Points are correspond of each. The three points should cover most areas, and two points are located in the diagonal display of the picture. Point one is green cross. Point two is red cross. Point three is blue cross.	[Setting method] Select from drop list.

Step 3 Click **Apply**. The message "**Apply success**" is displayed, the system saves the settings.

----End

4.6.7 Bad Point Check

Description

The points that can't move when the environment or scenario change is bad point. You can delete the bad point by bad point check function.

Procedure

Step 1 Choose **Configuration > Thermal > Bad Point Check**

The **Bad Point Check** page is displayed, as shown in Figure 4-17.

Figure 4-17 Bad Point Check



Figure 4-18

 **NOTE**

If the image is defected by detector's fault, user can test the function to recover the bad point. User should connect the manufactory at this condition to make sure to apply.

Step 2 Click the white point at image, click **Apply** to recover the bad point, as shown in Figure 4-19

Figure 4-19 Recover bad point



Step 3 Click **Reset** to return the previous settings.

Step 4 Click **Apply**. The message "Apply success" is displayed, the system saves the settings.

----End

4.6.8 LED Control Parameter

Procedure

Step 1 Choose **Configuration > Thermal > LED Control Parameter**.

The **LED Control Parameter** page is displayed, as shown in Figure 4-17.

Figure 4-20 LED Control Parameter

 Led Control Param

ID	0 ▼
Display Mode	Open ▼

 Led Control Param

ID	0 ▼
Display Mode	Flicker ▼
Flicker Interval(100-10000MS)	200

 Led Control Param

ID	0 ▼
Display Mode	Timing ▼

		0	1	2	3	4	5	6	7	8	9	10	11	12	13	14	15	16	17	18	19	20	21	22	23	24
Sun																										
Mon																										
Tues																										
Wed																										
Thur																										
Fri																										
Sat																										

Table 4-8 Parameter of thermal mapping

Parameter	Description	Setting
Display mode	There are four modes, Close/Open/Flicker/Timing .	[Setting method] Select from drop list.

Parameter	Description	Setting
Flicker interval(100-10000 ms)	Display mode is Flicker , and user need to set an interval to flash the LED.	[Setting method] Input an integer from 100 to 10000
Schedule	Display mode is Timing , user to set time to open LED.	[Setting method] Drag mouse to select the time, or click  to choose one day or one week.

Step 2 Click **Apply** to save the settings, as shown in Figure 4-19
--End

5 Thermal Parameter Configuration

5.1 Access the Sensor Setting Interface

Operation procedure:

Method 1:

- Step 1 On the web interface or client interface, move the cursor to the real-time video page and right-click on the page. A shortcut menu is displayed, as shown in Figure 5-1, and Table 5-1 describes the sensor setting interface.

Figure 5-1 Sensor Setting interface

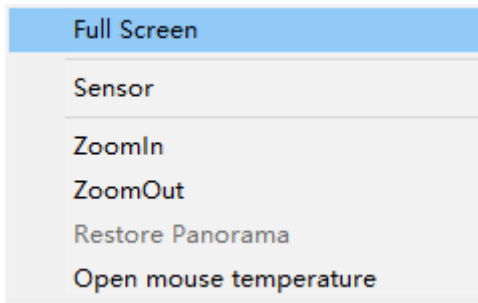

Table 5-1 Sensor Setting interface

Parameter	Description
Full Screen	It enlarges and displays the image in full screen.
Hide Info	It refers to the function that hides the IP address, code rate and other information of the functioning imaging device on the Client Side. Note: This function is only applicable to the Client Side and not for the WEB Side.
Sensor Configure	It is used for configuring the parameter set of front-end images.
Zoom In/Out	It zooms in/out images by electronic means. This function may also be used with the mouse wheel.
Open mouse temperature	Click this, and mouse cursor display temperature of point that cursor's position.

Step 2 Choose **Sensor Configure** and the **Sensor Setting** dialog box appears.

Method 2:

Step 3 At “**Configuration > Sensor Setting**” interface, choose channel 2 to enter the setting interface, as shown in .

Figure 5-2 Sensor setting

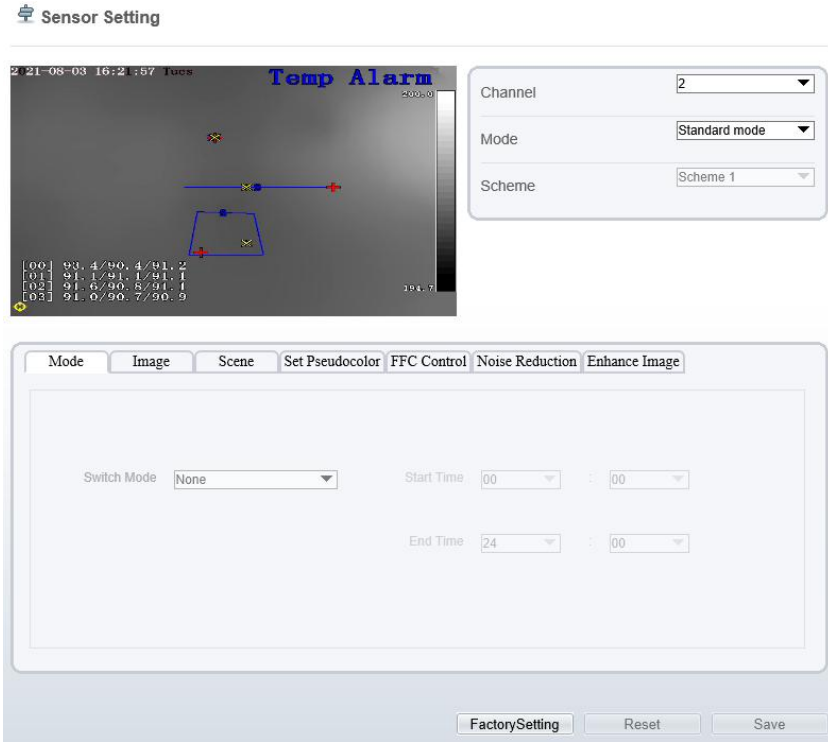

----End

5.2 Sensor Setting Parameter description

5.2.1 Mode

Operation procedure:

Step 1 Click **Mode** tag on sensor setting interface, the time segment page is displayed, as shown in Figure 5-3.

Figure 5-3 Time Segment page

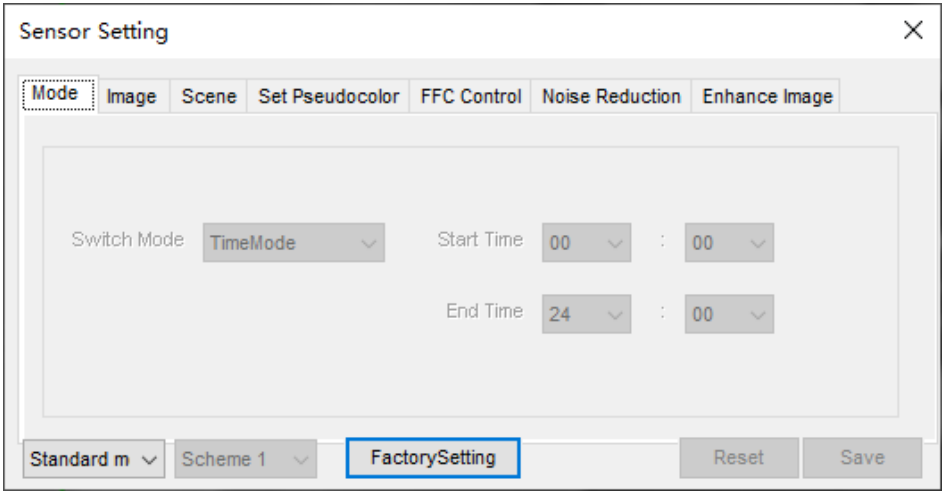

Step 2 Choose Debug Model in the lower left corner to activate the sensor setting page.

Step 3 Set the switch mode parameters.

Step 4 Click **Save** to save the setting.

----End

5.2.2 Image Setting

Figure 5-4 shows the image setting interface.

Figure 5-4 Image setting interface

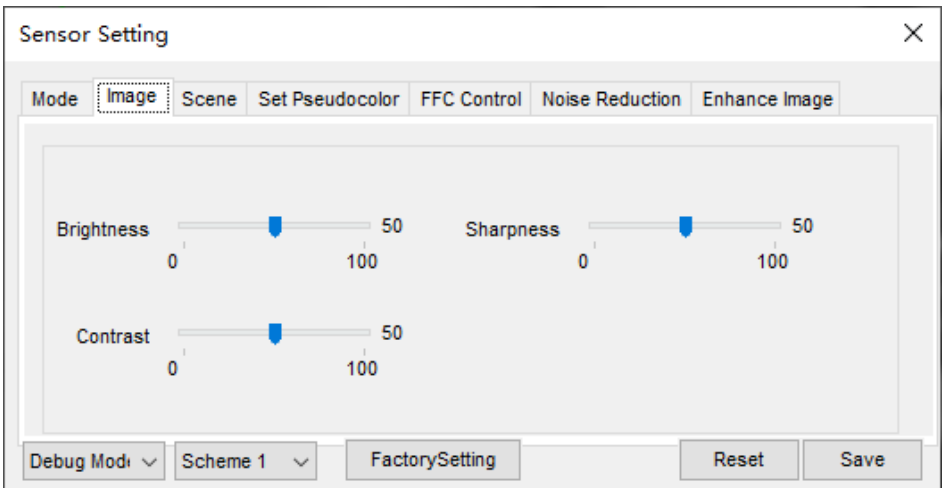

Table 5-2 describes the image setting parameters.

Table 5-2 Image setting parameter description

Parameter	Description	Setting
Brightness	It indicates the total brightness of an image. As the value increases, the image becomes brighter.	[Setting method] Drag the slider. [Default value] 50
Contrast	It indicates the contrast between the bright part and the dark part of an image. As the value increases, the contrast increases.	[Setting method] Drag the slider. [Default value] 50
Sharpness	It indicates the sharpness of the image plane and the sharpness of the image edge. The shaper the image, the better detail contrast.	[Setting method] Drag the slider. [Default value] 50

----End

5.2.3 Scene

Figure 5-5 shows the scene interface.

Figure 5-5 Scene interface

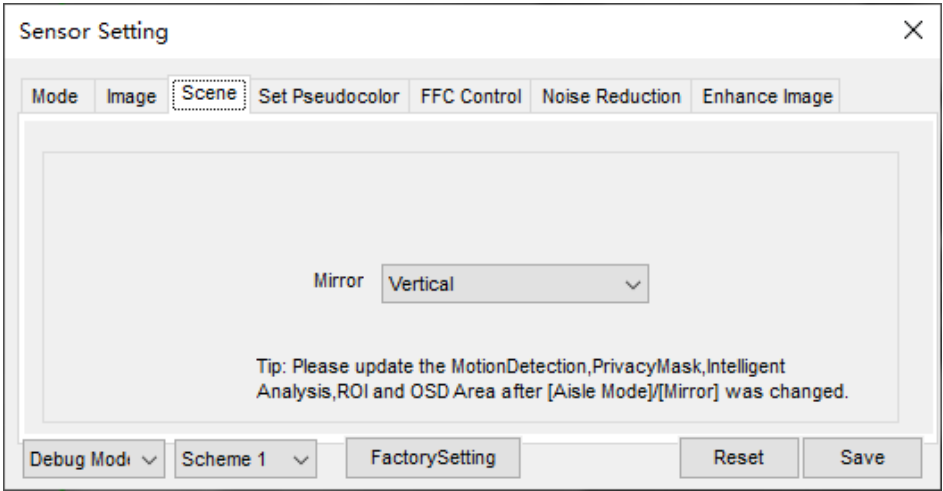

Provide the selection of image pixel locations.

Normal: the image is not flipped.

Horizontal: the image is flipped left and right.

Vertical: the image is flipped up and down.

Horizontal + Vertical: the image upside-down and reversal.

5.2.4 Set Pseudocolor

Figure 5-6 shows the set pseudocolor interface.

Figure 5-6 set pseudocolor interface

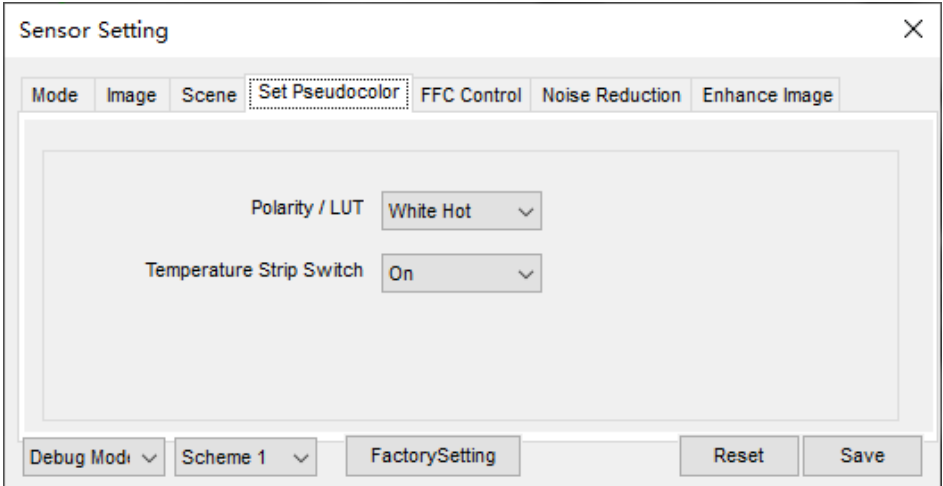

Polarity/LUT: the temperatures of the temperature fields detected by the thermal imaging camera are separately mapped to values ranging from 0 to 255 by the algorithm. In the black/white display mode, this range is converted to the grayscale tones. For example, 0 indicates completely black, and 255 indicates completely white. The temperature field of the scene is converted to images by using the grayscale ranging from 0 to 255. Different polarity modes can be converted to different display images. The most common setting is white hot (a hotter object is displayed brighter than a colder object) or black hot (a hotter object is displayed darker than a colder object). The difference between two modes lies in that the temperatures corresponding to the darker one and the lighter one are reversed. Other modes include rainbow, ironbow, HSV, autumn, bone and so on.

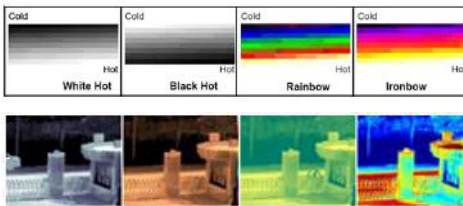

Temperature strip switch is on, the live video will show it, otherwise is no strip.

5.2.5 FFC Control

Figure 5-7 shows the FFC mode interface.

Figure 5-7 FFC mode interface

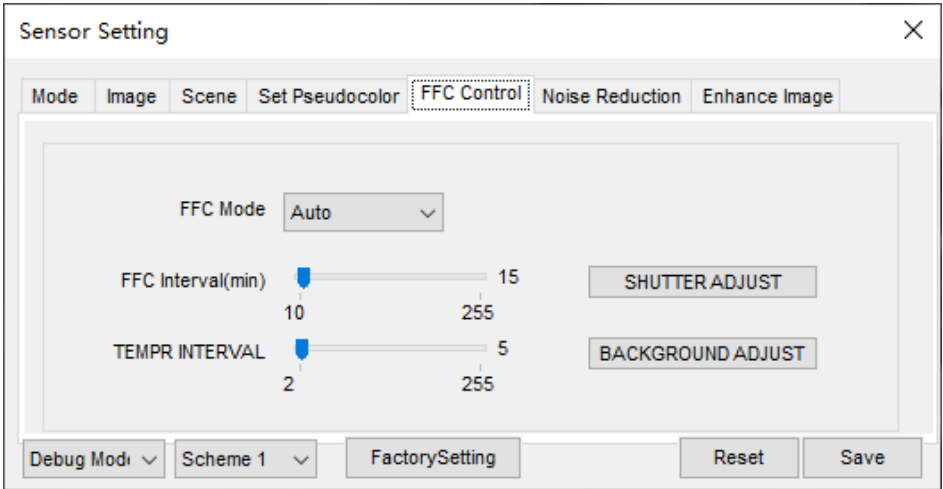

Table 5-3 describes the FFC mode parameters.

Table 5-3 FFC control parameter description

Parameter	Description	Setting
FFC Mode	<p>The internal of the thermal imaging camera may comprise the mechanical action correction mechanism that can periodically improve the image quality. This component is called flat field correction (FFC). When controlling the FFC, the FFC shields the sensor array, so that each portion of the sensor can collect uniform temperature fields (flat field). By means of FFC, the camera can update the correction coefficients to output more uniform images. Throughout the FFC process, the video image is frozen for two seconds and a static-frame image is displayed. After the FFC is complete, the image is automatically recovered. Repeated FFC operations can prevent the grainy and image degradation problems. The FFC is especially important when the temperature of the camera changes. For example, after the camera is powered on or the ambient temperature is changed, you should immediately perform the FFC.</p> <p>Auto: In the Automatic FFC mode, the camera performs FFC whenever its temperature changes by a specified amount or at the end of a specified period of time (whichever comes first). When this mode is selected, the FFC interval (minutes)</p>	<p>[How to set] Select from the drop-down list box. [Default value] Auto</p>

Parameter	Description	Setting
	<p>ranges from 10 to 255 minutes. The temperature change of the camera is based on the temperatures collected by the internal temperature probe. The temperature of the camera sharply changes when the camera is powered on. The FFC is relatively frequent, which is normal.</p> <p>Manual: In the manual FFC mode, the camera does not automatically perform the FFC based on the temperature change or the specified period. Choose manual mode, when you feel that the image is obviously degraded but the automatic FFC is not performed, you can use the manual FFC function to check whether the image quality can be improved.</p>	
FFC Interval (min)	In the automatic FFC mode, the FFC interval ranges from 5 to 255 minutes.	[How to set] Drag the slider. [Default value] 5
Temper Interval	In the automatic FFC mode, the FFC interval ranges from 5 to 25.5 centigrade.	[How to set] Drag the slider. [Default value] 5
Shutter Adjust	Click the icon to adjust exposure immediately.	N/A
Background Adjust	Click the icon and cover the camera with something to adjust image. Remove the thing to finish adjustment.	N/A

----End

5.2.6 Noise Reduction

Figure 5-8 shows the Noise reduction interface.

Figure 5-8 Noise reduction interface

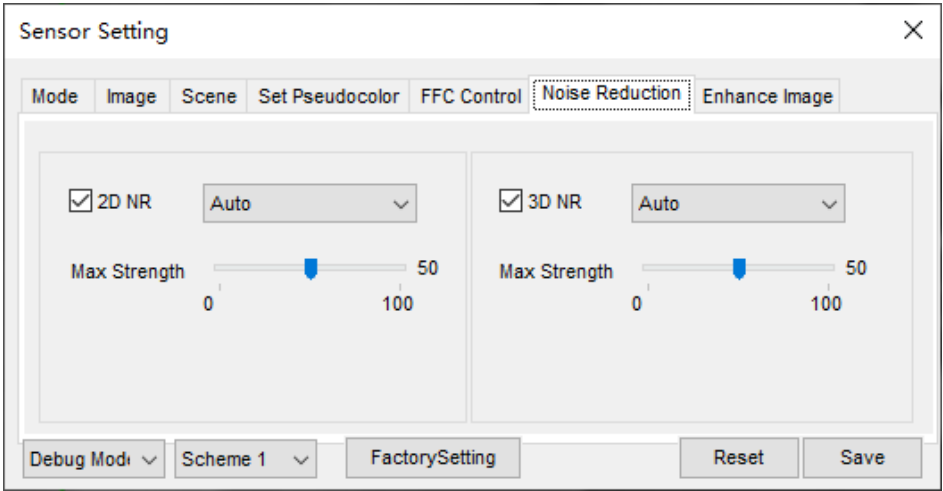

Table 5-4 describes noise reduction parameters.

Table 5-4 DNR parameter description

Parameter	Description	Setting
2 DNR	Decrease the image noise.	[How to set] Select from the drop-down list box. Drag the slider to adjust max strength. [Default value] Auto
3 DNR	Decrease the image noise.	[How to set] Select from the drop-down list box. Drag the slider to adjust max strength. [Default value] Auto

----End

5.2.7 Enhance Image

Figure 5-9 shows the screen adjustment interface and Table 5-5 shows the screen adjustment parameter..

Figure 5-9 Enhance image interface

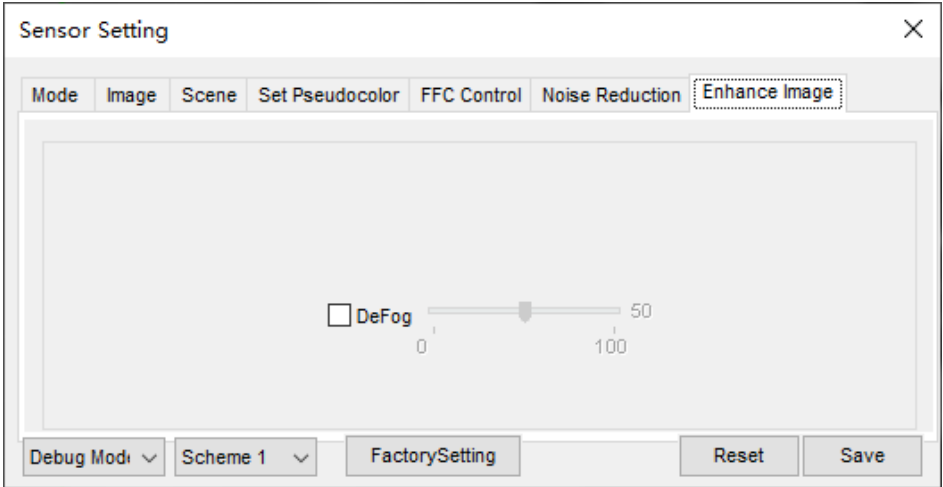

Table 5-5 Screen adjustment parameter description

Parameter	Meaning	Configuration Method
Defog	Decrease the image fog.	[How to set] Drag the slider. [Default value] 50

----End

6 Visible-light Parameter Configuration

6.1 Access the Sensor Interface

Operation procedure

Step 1 On the web or NVMS interface, move the cursor to the real-time video page and right-click on the page. A shortcut menu is displayed, as shown in Figure 6-1.

Figure 6-1 Sensor Setting interface

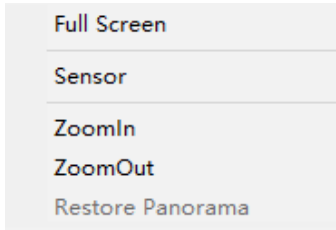

Step 2 Choose **Sensor Configure** and the **Sensor Setting** dialog box appears.

Step 3 User can also set parameters at “Configuration > Sensor Setting ” interface, the channel is chosen 1, as shown in Figure 6-2.

Figure 6-2 Sensor setting

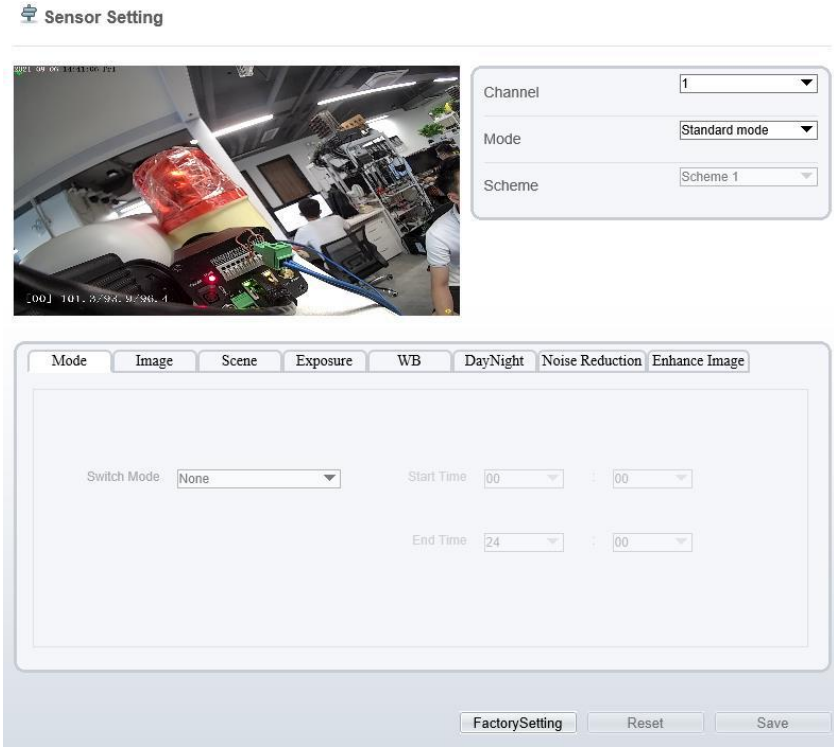

----End

6.2 Sensor Setting Parameter description

6.2.1 Mode

Operation procedure:

- Step 1 Click **Mode** tag on sensor setting interface, the time segment page is displayed, as shown in Figure 6-3.

Figure 6-3 Mode page

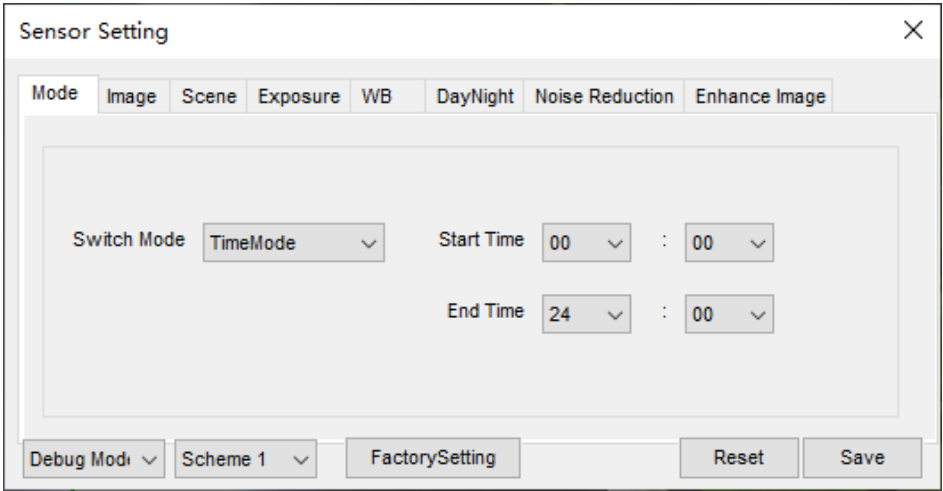

Step 2 Choose Debug Model in the lower left corner to activate the sensor setting page.

Step 3 Set the time segment parameters.

Step 4 Click **Save** to save the setting.

----End

6.2.2 Image Adjust

Figure 6-4 shows the Image Adjust tab page.

Figure 6-4 Image Adjust tab page

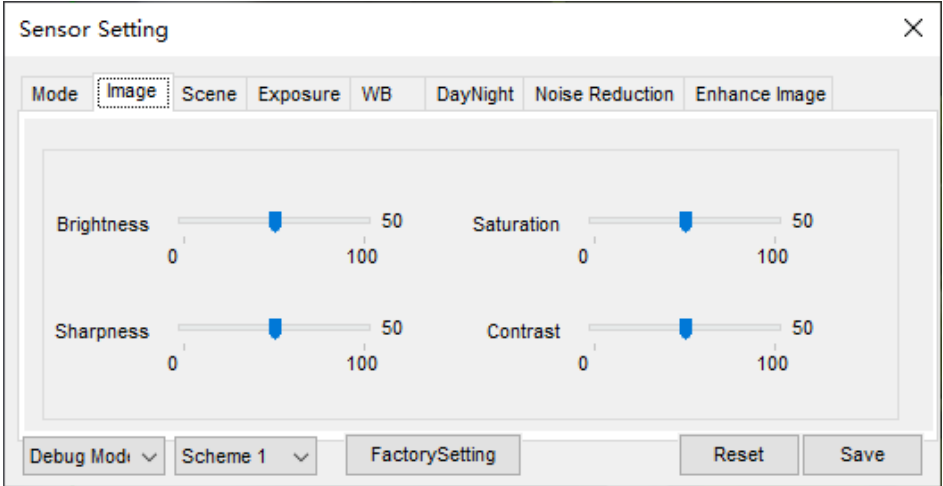

Table 6-1 describes the parameters on the Image Adjust tab page.

Table 6-1 Parameters on the Image Adjust tab page

Parameter	Description	Configuration Method
Contrast	It indicates the contrast between the bright part and the dark part of an image. As the value increases, the contrast increases.	[Setting method] Drag the slider. [Default value] 50
Brightness	It indicates the total brightness of an image. As the value increases, the image becomes brighter.	[Setting method] Drag the slider. [Default value] 50
Sharpness	It indicates the border sharpness of an image. As the value increases, the borders become clearer, and the number of noise points increases.	[Setting method] Drag the slider. [Default value] 50
Saturation	It indicates the color saturation of an image. As the value increases, the image becomes more colorful.	[Setting method] Drag the slider. [Default value] 50

----End

6.2.3 Scene Mode

Figure 6-5 shows the scene mode interface.

Figure 6-5 Scene mode interface

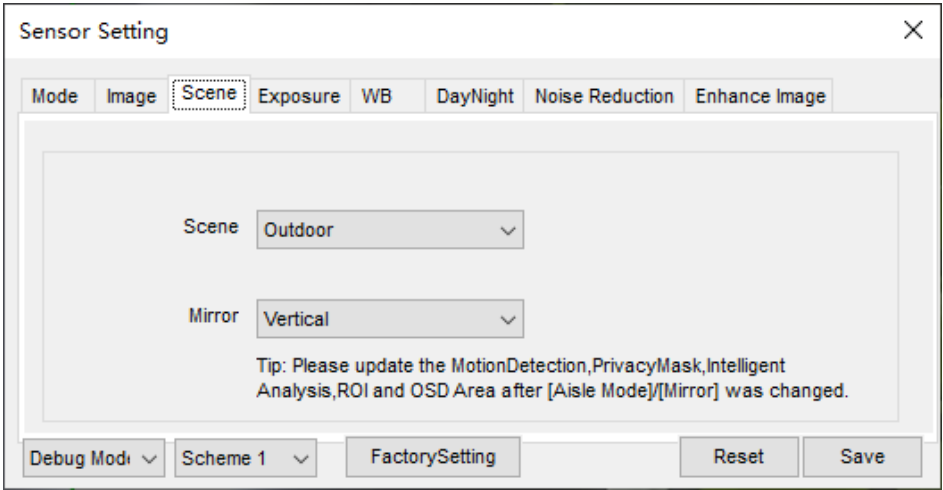

Table 6-2 describes the FFC mode parameters.

Table 6-2 FFC mode parameters description

Parameter	Description	Configuration Method
Scene	<p>It indicates the working mode of a camera..</p> <ul style="list-style-type: none">• Outdoor: It applies to outdoor scenarios.• Indoor: It applies to indoor scenarios.	<p>[Configuration method] Select from the drop-down list [Default value] Outdoor</p>

Parameter	Description	Configuration Method
Mirror	It is used to select the pixel location of an image. <ul style="list-style-type: none">• Normal: The image does not flip.• Horizontal: The image flips to the left and right.• Vertical: The image flips up and down.• Horizontal and vertical: The image rotates at 180 degrees.	[Setting method] Select a value from the drop-down list. [Default value] Normal

----End

6.2.4 Exposure

Figure 6-6 shows the Exposure interface.

Figure 6-6 Exposure interface for high speed dome

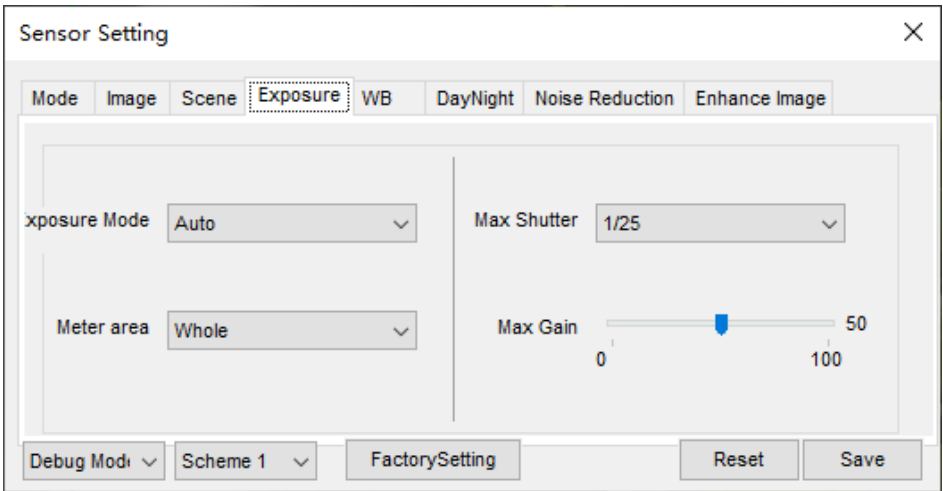

Table 6-3 describes Exposure parameters.

Table 6-3 Exposure parameters description

Parameter	Meaning	Configuration Method
Exposure Mode	<p>The exposure modes include:</p> <ul style="list-style-type: none"> • Auto: The system performs auto exposure based on the monitoring environment. • Manual: You can adjust the brightness of an image by setting the following three items: Shutter Setting, Iris Setting and Gain Setting. • Shutter Priority: You can set Shutter Setting to fixed values. The iris and gain are automatically adjusted by the system. • Iris Priority (for high speed dome): You can set Iris Setting to fixed values. The shutter and gain are automatically adjusted by the system. 	<p>[Setting method] Select a value from the drop-down list. [Default value] Auto</p>
Max Shutter	<p>The device automatically adjusts the shutter time based on the ambient brightness. The shutter time is less than or equal to the value of this parameter.</p>	<p>[Setting method] Select a value from the drop-down list. [Default value] 1/25</p>
Max Gain	<p>The device automatically adjusts the gain based on the external light. The gain is less than or equal to the value of this parameter.</p>	<p>[Setting method] Drag the slider. [Default value] 50</p>
Iris	<p>It is valid in manual mode and iris priority mode. You can adjust the brightness of an image by setting the iris. As the value increases, the brightness increases (when the shutter and gain remain the same). However, the camera movement automatically adjusts the shutter and gain in this mode. Therefore, the brightness of an image may not increase when you increase the iris.</p>	<p>[Setting method] Select a value from the drop-down list. [Default value] F1.6</p>

----End

6.2.5 WB Setting

Figure 6-7 shows the **WB Setting** interface.

Figure 6-7 WB Setting interface

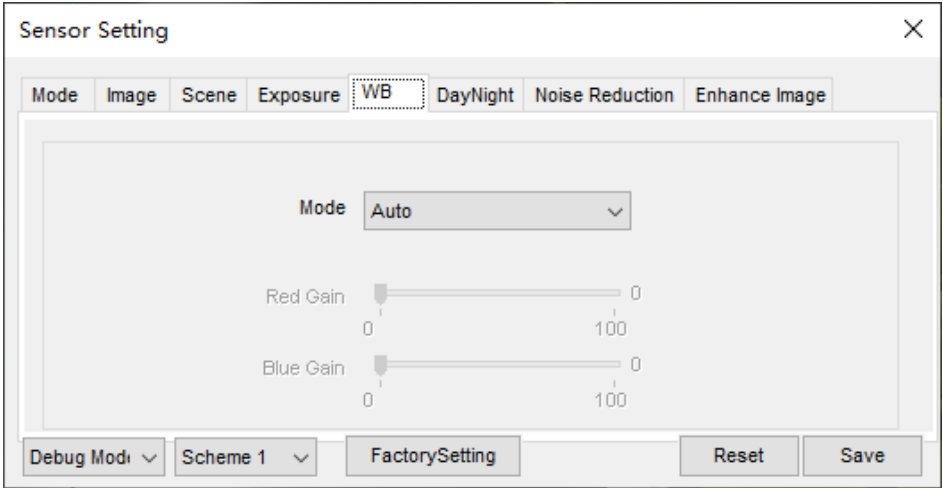



Table 6-4 describes **WB Setting** parameters.

Table 6-4 **WB Setting** parameters description

Parameter	Meaning	Configuration Method
Mode	<p>It is adjusted based on application scenarios to improve the fidelity of the image color. The WB modes include:</p> <ul style="list-style-type: none"> • Auto: In automatic white balance (WB) mode, the system automatically performs white balance based on the monitoring environment. • Tungsten • Fluorescent • Daylight • Shadow • Manual: In manual WB mode, you can manually select a WB mode based on the monitoring environment. 	<p>[Setting method] Select a value from the drop-down list. [Default value] Auto</p>

Parameter	Meaning	Configuration Method
Red Gain	<p>It indicates the gain applied to red channels. As the value increases, the color temperature becomes lower.</p> <p> NOTE This parameter is valid when Manual Mode is set to Customized.</p>	<p>[Setting method] Drag the slider. [Default value] 0</p>
Blue Gain	<p>It indicates the gain applied to blue channels. As the value increases, the color temperature becomes higher.</p> <p> NOTE This parameter is valid when Manual Mode is set to Customized.</p>	<p>[Setting method] Drag the slider. [Default value] 0</p>

6.2.6 Daynight

The day night mode settings vary based on device models. For details, see the following sections.

Figure 6-8 shows the **DayNight Mode** interface.

Figure 6-8 DayNight Mode interface

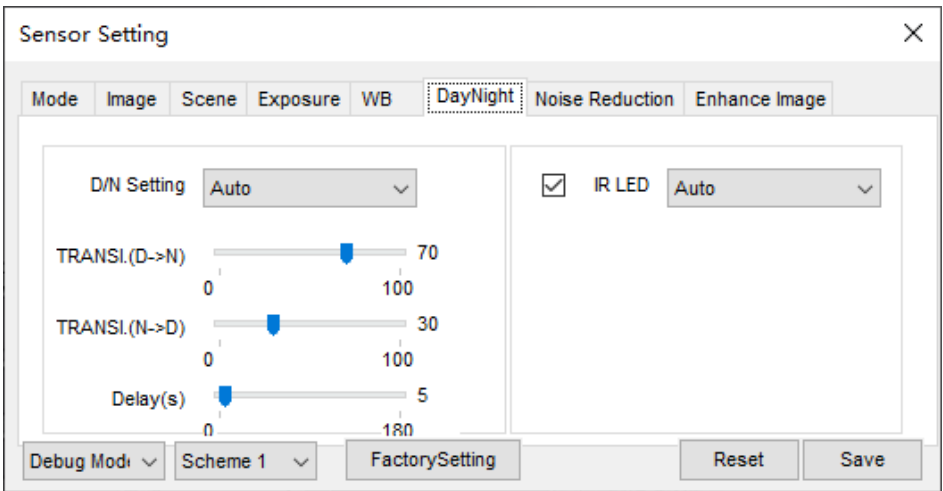





Table 6-5 describes **DayNight Mode** parameters.

Table 6-5 DNR parameters description

Parameter	Meaning	Configuration Method
<p>D/N Setting Mode</p>	<p>It can be set to Auto, Day, Night or Timing.</p> <ul style="list-style-type: none"> • Auto mode The image color and filter status are automatically switched based on the ambient brightness. The filter prevents infrared light from entering the sensor in the day state and allows all types of light to enter the sensor in the night state. • Day mode The image is colored, and the filter is in the day state, preventing infrared light from entering the sensor. • Night mode The image is black and white, and the filter is in the night state, allowing infrared light to enter the sensor. • Timing Set day to night time and night to day time to switch the daynight mode. 	<p>[Setting method] Select a value from the drop-down list. [Default value] Auto</p>
<p>TRANSL.(D->N)(dB)</p>	<p>It determines the day-to-night switching in auto mode. When the system gain is greater than the value of this parameter, the system enters the night mode.</p> <p> NOTE</p> <p>This parameter is valid in auto mode. The value of TRANSL.(D->N) must be greater than the value of TRANSL.(N->D).</p>	<p>[Setting method] Drag the slider. [Default value] 70</p>

Parameter	Meaning	Configuration Method
TRANSL.(N->D)(dB)	<p>It determines the night-to-day switching in auto mode. When the system gain is smaller than the value of this parameter, the system enters the day mode.</p> <p> NOTE This parameter is valid in auto mode. The value of TRANSL.(D->N) must be greater than the value of TRANSL.(N->D).</p>	<p>[Setting method] Drag the slider. [Default value] 30</p>
Delay(s)	<p>The delay time of day to night or night to day.</p> <p> NOTE This parameter is valid in auto mode.</p>	<p>[Setting method] Drag the slider. [Default value] 0</p>
DTN Time	<p>Time of day to night.</p>	<p>[Setting method] Select a value from the drop-down list. [Default value] 18:00</p>
NTD Time	<p>Time of night to day.</p>	<p>[Setting method] Select a value from the drop-down list. [Default value] 6:00</p>

6.2.7 Noise Reduction

Figure 6-9 shows the Noise Reduction interface.

Figure 6-9 Noise Reduction interface

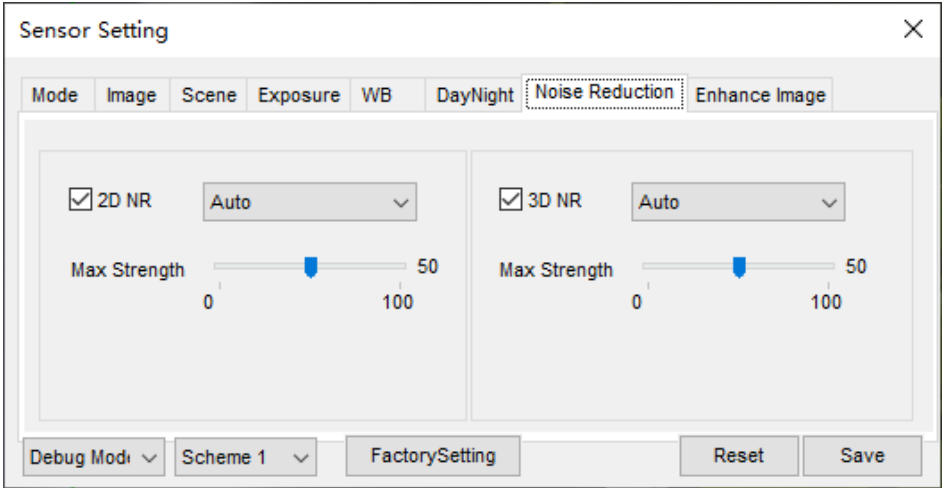

Table 6-6 describes DNR parameters.

Table 6-6 DNR parameters description

Parameter	Meaning	Configuration Method
2D NR	Reduce noise of image.	[Configuration method] Select from the drop-down list [Default value] Auto
Max Strength	It is valid in auto noise filter mode. When the parameter value is 0, the noise filter is disabled. When the parameter value is greater than 0, the noise filter is enabled, and the system automatically adjusts the noise filter level based on the ambient brightness without exceeding the value of this parameter.	[Setting method] Drag the slider. [Default value] 50
3D NR	Reduce noise of image.	[Configuration method] Select from the drop-down list [Default value] Auto

Parameter	Meaning	Configuration Method
Max Strength	It is valid in auto noise filter mode. When the parameter value is 0 , the noise filter is disabled. When the parameter value is greater than 0 , the noise filter is enabled, and the system automatically adjusts the noise filter level based on the ambient brightness without exceeding the value of this parameter.	[Setting method] Drag the slider. [Default value] 50

6.2.8 Enhance Image

Figure 6-10 shows the enhance image interface and Table 6-7 shows the enhance image parameter.

Figure 6-10 Enhance image interface

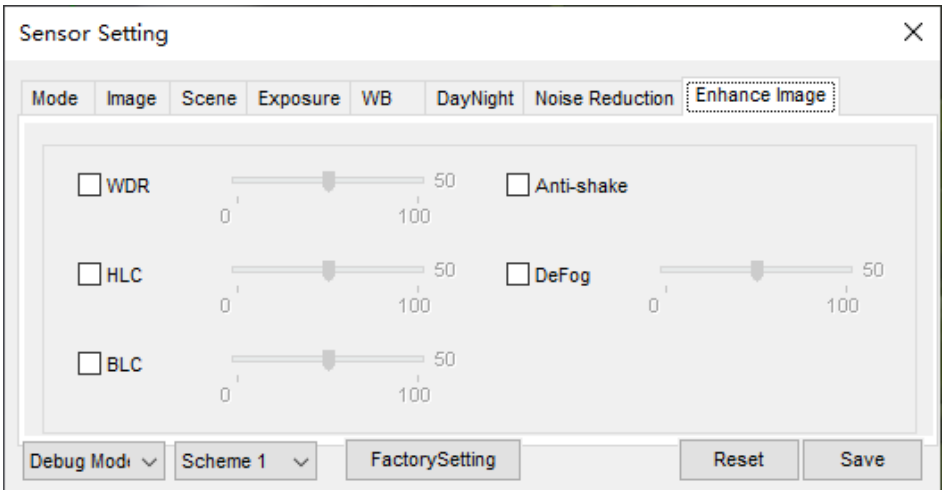

Table 6-7 Enhance image parameters description

Parameter	Meaning	Configuration Method
WDR	It is used to display the foreground and background at the same time in the environment with a large brightness difference. When the brightness difference is larger, you can increase the WDR level to obtain better image effect.	[Setting method] Tick the WDR mode and drag the slider. [Default value] 50
HLC	It provides a clearer view of an image in the highlight environment. When HLC is enabled, the total brightness of an image is reduced, allowing you to view objects in front of the highlight.	[Setting method] Tick the HLC mode and drag the slider. [Default value] 50
BLC	It provides a clearer view of an image in the backlight environment. When BLC is enabled, the total brightness of an image increases, allowing you to view objects in front of the backlight. Meanwhile, the objects behind the backlight are exposed excessively.	[Setting method] Tick the BLC mode.
DeFog	It provides a clearer view of an image in the fogged environment when Defog is enabled. As the value increases, the image becomes clearer.	[Setting method] Tick the Defog mode and drag the slider. [Default value] 50

7 Camera Maintenance

At “Configuration > Maintenance” interface, user can restart, auto reboot, update device, restore to factory default, save to local hard drive(the configuration will be saved), load from local hard drive, as shown in Figure 7-1.

Figure 7-1 Camera maintenance

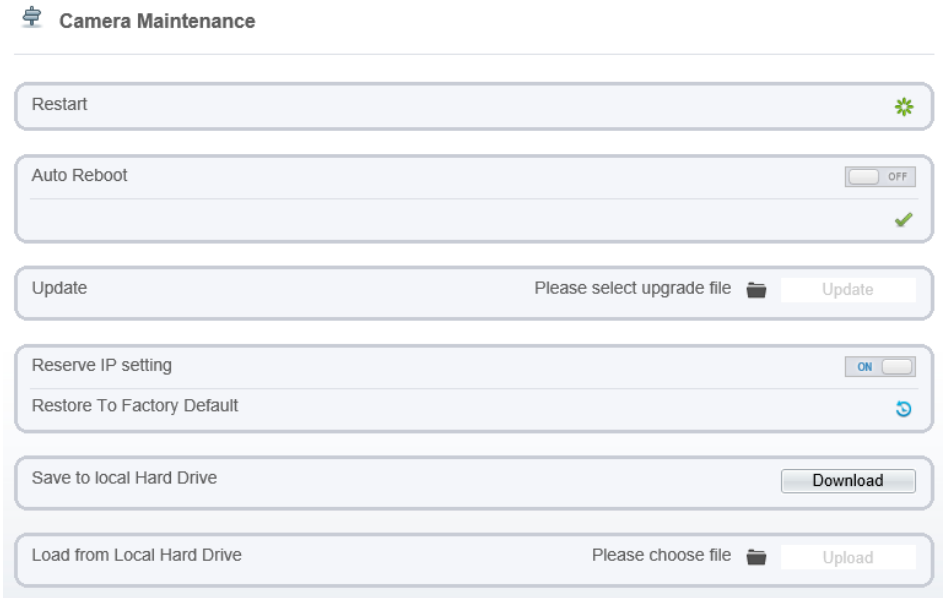

A Common Emission Rate

Emission Rate

The emission rate is the capability of an object to emit or absorb energy. An ideal transmitter provides an emission rate of emitting 100% of intake energy. An object with an emission rate of 0.8 can absorb 80% of intake energy, and reflect the remaining 20%. The emission rate is the ratio of the energy emitted by an object at a specific temperature to that emitted by an ideal radiator at the same temperature. The range of emission rate value is 0.0 to 1.0 generally.

Materials	Temperature (°C/°F)	Emissivity
Gold (High-purity)	227/440	0.02
Aluminum foil	27/81	0.04
Aluminum sheet	27/81	0.18
Aluminum used for families (flat)	23/73	0.01
Aluminum plate (98.3% purity)	227/440	0.04
	577/1070	0.06
Aluminum plate (rough)	26/78	0.06
Aluminum (oxidized @ 599 °C)	199/390	0.11
	99/1110	.19
Polished aluminum	38/100	0.22
Tin (light tinned Iron sheet)	25/77	0.04
Nickel wire	187/368	0.1
Lead (99.9% purity, No oxidized)	127/260	0.06

Copper	199/390	0.18
Cobalt	599/1110	0.19
Steel	199/390	0.5
	599/1110	0.57
Tinned iron sheet (Light)	28/82	0.23
Brass(High-polish)	247/476	0.03
Brass (Tough rolled, polished metal wire)	21/70	0.04
Tinned Iron (Light)	-	0.13
Iron plate (Rust eaten)	20/68	0.69
Rolled steel sheet	21/71	0.66
Ferric oxide	100/212	0.74
Wrought-iron	21/70	0.94
Fused iron	1299-1399/3270-2550	0.29
Copper (Polished)	21-117/70-242	0.02
Copper(Polished, not reflected)	22/72	0.07
Copper (Heavy oxide Board)	25/77	0.78
Enamel (Fuse on iron)	19/66	0.9
Formica Plate	27/81	0.94
Frozen soil	-	0.93
Brick (Red, rough)	21/70	0.93
Brick (Unglazed, rough)	1000/1832	0.8
Carbon (T - carbon 0.9% ash)	127/260	0.81

Concrete	-	0.94
Glass (Glossy)	22/72	0.94
Granite (Surfaced)	21/70	0.85
Ice	0/32	0.97
Marble (I Polished, grey)	22/72	0.93
Asbestos board	23/74	0.96
Asbestos paper	38/100	0.93
	371/700	0.95
Asphalt (Paving the road)	4/39	0.97
Paper (Black tar)	-	0.93
Paper (White)	-	0.95
Plastic (White)	-	0.91

101-300-0646-01