

Bi-Spectral PTZ Network Camera User Manual

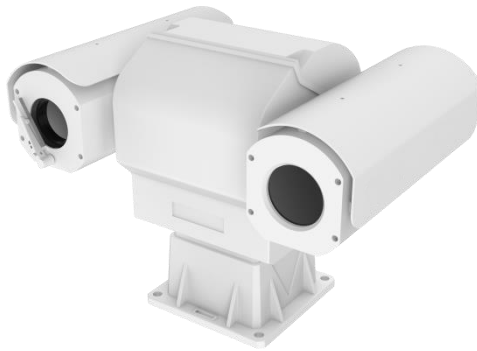

Issue

V 1.1

Date

2019-09-04





Precautions

Precautions

Fully understand this document before using this device, and strictly observe rules in this document when using this device. If you install this device in public places, provide the tip "You have entered the area of electronic surveillance" in an eye-catching place. Failure to correctly use electrical products may cause fire and severe injuries. To prevent accidents, carefully read the following context:

Symbols

This document may contain the following symbols whose meanings are described accordingly.

Symbol	Description
 DANGER	It alerts you to fatal dangers which, if not avoided, may cause deaths or severe injuries.
 WARNING	It alerts you to moderate dangers which, if not avoided, may cause minor or moderate injuries.
 CAUTION	It alerts you to risks. Neglect of these risks may cause device damage, data loss, device performance deterioration, or unpredictable results.
 TIP	It provides a tip that may help you resolve problems or save time.
 NOTE	It provides additional information.

DANGER

To prevent electric shocks or other dangers, keep power plugs dry and clean.

WARNING

- Strictly observe installation requirements when installing the device. The manufacturer shall not be held responsible for device damage caused by users' non-conformance to these requirements.

- Strictly conform to local electrical safety standards and use power adapters that are marked with the LPS standard when installing and using this device. Otherwise, this device may be damaged.
- Use accessories delivered with this device. The voltage must meet input voltage requirements for this device.
- If this device is installed in places with unsteady voltage, ground this device to discharge high energy such as electrical surges in order to prevent the power supply from burning out.
- When this device is in use, ensure that no water or any liquid flows into the device. If water or liquid unexpectedly flows into the device, immediately power off the device and disconnect all cables (such as power cables and network cables) from this device.
- Do not expose the thermal imaging camera or unpacked product to extremely strong radiation sources, such as the sun, laser, or arc welding machine, regardless of whether the device is being electrified or not; do not put the camera close to high thermal objects such as the sunlight; otherwise, the precision of the camera may be affected and even the detector inside the camera may suffer a permanent damage.
- If this device is installed in places where thunder and lightning frequently occur, ground the device nearby to discharge high energy such as thunder strikes in order to prevent device damage.

**CAUTION**

- Unless otherwise specified, do not use the camera in a temperature lower than -10 °C (+14 °F) or higher than +50 °C (+122 °F). Too-high or too-low temperature may cause image display anomaly of the camera and the camera will be damaged if it is working under such a condition for a long time.
- If the camera is installed outdoors, avoid direct sunlight at dawn and dusk on the camera lens and install a sunshield with frontal and rear positions adjusted according to the sunlight angle.
- Avoid heavy loads, intensive shakes, and soaking to prevent damages during transportation and storage. The warranty does not cover any device damage that is caused during secondary packaging and transportation after the original packaging is taken apart.
- Protect this device from fall-down and intensive strikes, keep the device away from magnetic field interference, and do not install the device in places with shaking surfaces or under shocks.
- Clean the device with a soft dry cloth. For stubborn dirt, dip the cloth into slight neutral cleanser, gently wipe the dirt with the cloth, and then dry the device.
- Since the camera lens is painted with a durable coating material, it adapts to outdoor environment. The lens must be cleaned regularly. If the image quality is reduced or excessive dirt is deposited on the lens, clean the lens in a timely manner. In sandy (in desert) or corrosive (on sea) environment, use the camera with caution; improper use may cause the coating to peel off.

- Do not jam the ventilation opening. Follow the installation instructions provided in this document when installing the device.
- Keep the device away from heat sources such as radiators, electric heaters, or other heat equipment.
- Keep the device away from moist, dusty, extremely hot or cold places, or places with strong electric radiation.
- If the device is installed outdoors, take insect- and moisture-proof measures to avoid circuit board corrosion that can affect monitoring.
- Remove the power plug if the device is idle for a long time.
- Before unpacking, check whether the fragile sticker is damaged. If the fragile sticker is damaged, contact customer services or sales personnel. The manufacturer shall not be held responsible for any artificial damage of the fragile sticker.

Special Announcement

All complete products sold by the manufacturer are delivered along with nameplates, operation instructions, and accessories after strict inspection. The manufacturer shall not be held responsible for counterfeit products.

This manual may contain misprints, technology information that is not accurate enough, or product function and operation description that is slightly inconsistent with the actual product. The manufacturer will update this manual according to product function enhancement or changes and regularly update the software and hardware described in this manual. Update information will be added to new versions of this manual without prior notice.

This manual is only for reference and does not ensure that the information is totally consistent with the actual product. For consistency, see the actual product.

Contents

Precautions	i
1 Overview	4
1.1 Principle of Thermal Imaging and Advantages	4
1.2 Product Introduction.....	4
1.2.1 Function	5
1.2.2 Product Features.....	5
1.3 Description of PTZ cable	6
1.3.1 Multi-cable.....	6
1.3.2 Aviation Alarm Cable	7
2 Device Dimensions	10
3 Device Installation	11
3.1 Installation Method	11
3.2 Device Installation.....	11
3.2.1 Installation of Basic Requirements.....	11
3.2.2 Basic Installation Tool.....	11
3.2.3 Installation Space and Installation Strength	12
3.2.4 Definition of Installation Wiring Harness	12
4 Quick Configuration	14
4.1 Thermal Web	14
4.1.1 Login and Logout.....	14
4.1.2 Main Page Layout	15
4.1.3 Change the Password	16
4.1.4 Browse Video.....	17
4.1.5 Install Plugins.....	19
4.1.6 Set Local Network Parameters	19
4.1.7 Thermal Settings	22
4.1.7.1 Temperature Parameters	22
4.1.7.2 Temperature Area	25
4.1.7.3 Shield Area	28
4.1.7.4 Schedule Linkage	29
4.1.7.5 Bad Point Check.....	31

4.2 Visible-light Web.....	32
4.2.1 Login and Logout.....	32
4.2.2 Main Page Layout	33
4.2.3 Change the Password	35
4.2.4 Browse Video.....	36
4.2.5 Set Local Network Parameters.....	38
5 Thermal Parameter Configuration.....	42
5.1 Access the Sensor Setting Interface.....	42
5.2 Sensor Setting Parameter description	43
5.2.1 Time Segment	43
5.2.2 Image Setting	43
5.2.3 Scene.....	45
5.2.4 Set Pseudocolor.....	45
5.2.5 FFC Control	46
5.2.6 Noise Reduction.....	48
5.2.7 Enhance Image.....	49
6 Visible-light Parameter Configuration.....	52
6.1 Access the Sensor Interface.....	52
6.2 Sensor Setting Parameter description	52
6.2.1 Time Segment	52
6.2.2 Image Adjust	53
6.2.3 Scene Mode.....	54
6.2.4 Exposure	56
6.2.5 WB Setting.....	57
6.2.6 Daynight.....	58
6.2.7 Noise Reduction.....	61
6.2.8 Enhance Image.....	62
6.2.9 Zoom Focus	64
7 PTZ Function Application.....	66
7.1 PTZ Control function	66
7.2 PTZ configuration	67
7.2.1 PTZ setting.....	67
7.2.2 Configure and Apply Preset	68
7.2.3 Configure and Apply Tracks	68
7.2.4 Configure and Apply Scan	69
7.2.5 Configure and Apply Tour.....	70
7.2.6 Configure and Apply Idle.....	71

7.2.7 Configure North	72
7.2.8 Configure Timer	73
7.2.9 Configure Extension.....	74
A Troubleshooting.....	75
B Common Emission Rate.....	78

1 Overview

1.1 Principle of Thermal Imaging and Advantages

Any object with temperature higher than the absolute zero (-273.15° F) will emit infrared (IR) ray, even though it does not emit light. The IR ray is also called thermal radiation. IR rays emitted by objects with different temperatures can be absorbed by the detector to reflect temperature change and thus generate an electric effect. The electric signal is amplified and processed to produce a thermal image that corresponds to the thermal distribution of the object surface. This is the process of thermal imaging.

- Adapt to any environment

Traditional cameras rely on natural or environmental light to shoot images, but this IR thermal imaging camera relies on the IR energy radiated by an object itself to form an image, not requiring any light. The IR thermal imaging camera is applicable to any environment and not affected by light strength. It can detect and identify any camouflage and concealed object both in daytime or nighttime, implementing round-the-clock monitoring.

- Monitor the temperature field with object energy distributed

The IR thermal imaging camera can show the temperature field of an object, converting the invisible surface temperature distribution situation to a visible thermal image that reflects the surface temperature distribution situation of the object. By this monitoring, users can discover temperature anomaly in a timely manner and take precautionary measures to avoid any risk that may be caused by the anomaly, for example, a fire.

- Boast cloud penetration capability

Visible light and near IR ray will be absorbed by the air, cloud and smoke, but they are transparent to IR ray of the 3~5 μm Medium Wavelength Infrared (MWIR) region and 8~14 μm Long Wavelength Infrared (LWIR) region. Traditional cameras cannot shoot clear images under cloudy environment, but the IR thermal imaging camera can penetrate the cloud and smoke to shoot clear images.

1.2 Product Introduction

Bi-Spectral PTZ Network Camera, the whole machine shell and the base are all made of high strength aluminum alloy material with comprehensive function and high stability. Can adapt to a variety of bad environment, heavy load can reach more than 50kg and run smoothly. This series has 360° continuous rotation,

automatic scanning, automatic cruise and other functions, suitable for large areas of monitoring, can be widely used in airports, stations, urban roads, traffic survey and monitoring, forest fire prevention, the high and heavy equipment rotary control and other important area.

1.2.1 Function

- To support a variety of scanning methods, such as cruise scan, pattern scanning, etc.
- It supports the function of power off memory and automatically returns to the monitoring scene before power off.
- Support network signal and analog signal double output, cloud platform control classification operation.
- The double helix structure of worm gear and worm drive, the electronic image stabilization, and mechanical locking design, power self-locking function.
- Horizontal continuous rotation 360 °, vertically +90 °~- 90 °rotating, horizontal velocity is 0.01 ~60 %S, vertical speed of 0.01 °~ 30 %S
- Support proportion variable times function, rotation speed adjusted automatically according to the lens change multiple times.
- Support watch features preset point/figure/cruise can stay idle scan specified Automatic call after time (including the idle state entered after power).

1.2.2 Product Features

- The shell of the machine adopts the material of high strength aluminum alloy die casting machine with anti-corrosion materials, anti-corrosion treatment, key parts filling nitrogen seal, all-weather protective design, IP66 protection grade, can adapt to the maritime and coastal defense environment such as salt fog video monitoring application.
- Double spiral worm gear transmission structure, mechanical anti-loosening design, power-off self-lock, strong wind resistance, high stability. Worm gear and worm drive design, level 360 °continuous rotation, horizontal speed can reach 60 %s
- Support multiple lens prepositioning function, change the adaptive function, the rotation speed can be adjusted according to the lens multiple times.
- Preset accuracy can be up to $\pm 0.1^\circ$
- Through the rain and fog: the common feature of thermal imaging products is that they are not affected by the rain and fog. Even in the forest, the frequent occurrence of rain and fog in the coastal areas can clearly capture the observed targets.
- Maximum support for 100 mm thermal imaging lens design.
- The imaging is clear: the thermal imaging system is able to produce clear and penetrating images through the dark environment with no light, the image is clear, the focal length is fine, and the optical fog is supported.
- The machine assembly is easy to operate and easy to maintain.

1.3 Description of PTZ cable

1.3.1 Multi-cable

Aviation power supply and network cable of twenty-six cores is shown as Figure 1-1 & Figure 1-2, and the description is shown in Table 1-1.

Figure 1-1 Aviation power supply and network cable of twenty-six cores



Figure 1-2 Definition of twenty-six cores

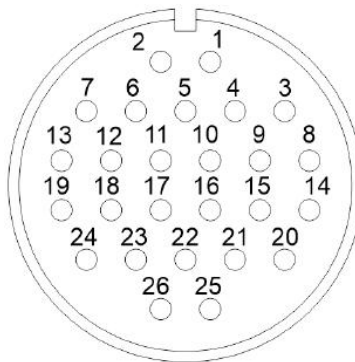

Table 1-1 Description of twenty-six cores

SN	Name	Description
1	DC36V -	Black (Thick)
2	DC36V +	Red (Thick)
3	DC36V -	Black (Thick)
4	DC36V -	Black (Thick)
5	Alarm_OUT1	Red (Thin)
6	DC36V +	Red (Thick)
7	DC36V +	Red (Thick)
8	Audio_IN(G)	Audio masking
9	Audio_IN	Audio Core
10	Alarm_OUT1	Black (Thin)
11	Alarm_OUT3	Blue
12	Alarm_OUT3	Pink
13	Alarm_OUT4	White
14	Audio_OUT(G)	Audio masking
15	Audio_OUT	Audio Core
16	Video	Video Core
17	Video (G)	Video masking
18	Alarm_OUT2	White and Orange
19	Alarm_OUT4	Green
20	RS485A	Orange (Thick)
21	RS485B	Yellow (Thick)
22	ETHTX+	White and Orange
23	ETHTX-	Orange
24	Alarm_OUT2	White and Yellow
25	ETHRX+	White and Green
26	ETHRX-	Green

1.3.2 Aviation Alarm Cable

Aviation alarm cable of twenty-six cores is shown as Figure 1-3& Figure 1-4, and the description is shown in Table 1-2.

Figure 1-3 Aviation power supply cable of twenty-six cores



Figure 1-4 Definition of twenty-six cores

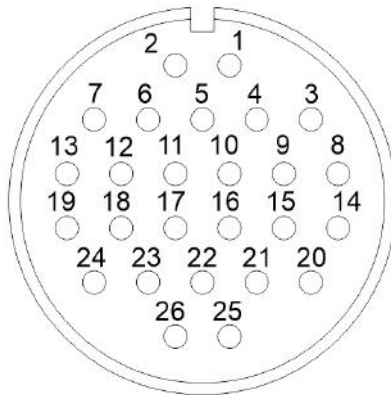

Table 1-2 Description of twelve cores

SN	Name	Description
1	Reserved core	Blank

SN	Name	Description
2	Reserved core	Blank
3	Reserved core	Blank
4	Reserved core	Blank
5	Reserved core	Ground
6	Reserved core	Blank
7	Reserved core	Blank
8	Reserved core	Ground
9	Reserved core	Ground
10	Reserved core	Blank
11	Alarm_IN1	White
12	Alarm_IN2	White and Orange
13	Alarm_IN3	Blue
14	Audio IN(G)	Audio masking
15	Audio_IN	Audio Core
16	Video	Video Core
17	Video (G)	Video masking
18	Audio_OUT	Audio Core
19	Audio_OUT(G)	Audio masking
20	Alarm_IN4	Pink
21	Alarm_IN5	Red (Thin)
22	Alarm_IN6	White and Yellow
23	Alarm_IN7	Blank
24	Alarm_IN8	Yellow (Thick)
25	Alarm_IN9	Orange (Thick)
26	Alarm_G	Black (Thick)

----End

2 Device Dimensions

Figure 2-1 shows the dimensions of the Bi-Spectral PTZ Network Camera.

Figure 2-1 Dimensions (unit: mm)

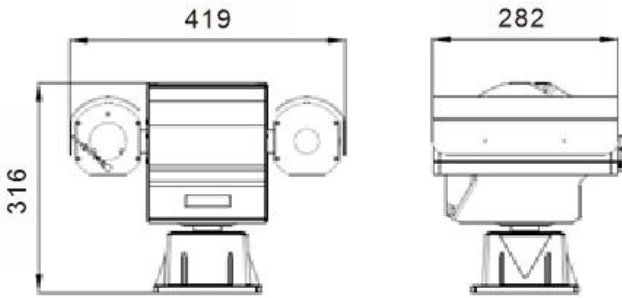

3 Device Installation

3.1 Installation Method

Bi-Spectral PTZ Network Camera can be installed on camera base.

Figure 3-1 shows the base dimensions of PTZ camera.

Figure 3-1 Base dimensions of PTZ camera (unit: mm)

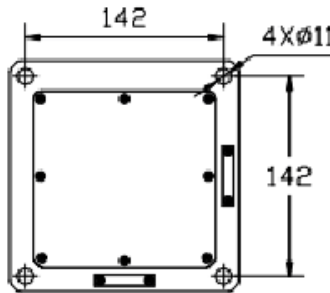

3.2 Device Installation

3.2.1 Installation of Basic Requirements

Installation site and environment to meet the technical parameters mentioned in the requirements, the installation staff should have been fully read and read the contents of this manual, with the appropriate system installation qualification and maintenance work qualification certificate.

Because the PTZ is heavier, please be sure to connect the power test PTZ before installation, whether it can be started normally and self-test, whether the PTZ control is normal and its function is normal, and when it is normal, it will be installed on site.

3.2.2 Basic Installation Tool

Commonly used engineering wiring and equipment installation tools, please install the equipment before the preparation is complete.

Table 3-1 shows the installation tools list.

Table 3-1 Installation tools

Name	Quantity	Remarks
13mm wrench	1	For mounting fixtures and mounting brackets
14mm sleeve	1	
Cross screwdriver(big)	1	For common construction
Cross screwdriver(small)	1	Used to disassemble the DIP cover to adjust the device communication parameters
Inside the hex wrench	1 set	Used for disassembly of pan / tilt pallet and shield connection
Word screwdriver (small)	1	to secure the wiring harness connection terminals
Wire strippers	1	Stripping

3.2.3 Installation Space and Installation Strength

Under normal circumstances, this device needs to be equipped with a protective cover or other overhead items, please confirm the installation location can accommodate this product and the equipment and installation of the structure of the space. To confirm the installation of the wall, the carrying capacity of the bracket can reach 4 times the safety of the entire equipment weight.

Install the device as shown, using the bolts and nuts in the fitting.

3.2.4 Definition of Installation Wiring Harness

The bottom line includes power line, network cable, RS422, geodetic line, video line, and according to the demand, there are various types of outgoing line. The details need to be controlled according to the line signature of each device.

Table 3-2 shows Definition of installation wiring harness.

Table 3-2 Definition of installation wiring harness

COLOR	Function define	Remark
BNC	Video	Optional
Red	DC36V+	N/A
Black	DC36V-	
RJ45	Network cable	
Orange	RS422 TX+	

COLOR	Function define	Remark
Yellow	RS422 TX-	
Red	RS422 RX+	
Blue	RS422 RX-	
Yellow & Green	GND	

 **NOTE**

In order to prevent lightning strikes, the grounding wire (yellow-green wire) in the cable outlet base must be grounded reliably and the grounding resistance should be $<4\Omega$.

----End

4 Quick Configuration

4.1 Thermal Web

4.1.1 Login and Logout



CAUTION

You must use Internet Explorer 8 or a later version to access the web management system; otherwise, some functions may be unavailable.

Login system

Step 1 Open the Internet Explorer, enter the IP address of IP camera (default value: 192.168.0.121) in the address box, and press Enter.

The login page is displayed, as shown in Figure 4-1.

Figure 4-1 Login page

The screenshot shows the login interface for an IP camera. It features a light blue background. At the top, the text 'IP CAMERA' is displayed in a large, bold, blue font. To the right of this text is a language selection dropdown menu currently set to 'English'. Below the title, there are two input fields: 'User Name' and 'Password'. To the right of these fields is a blue 'Login' button.

Step 2 Input the User name and password.

NOTE

- The default user name is **admin**. The default password is **admin**. Change the password when you login the system for first time to ensure system security.
- You can change the system display language on the login page.

Step 3 Click Login.

The main page is displayed.

----End

Logout

To logout of system, click  in the upper right corner of the main page, the login page is display after you log out of the system.

4.1.2 Main Page Layout



On the main page, you can view real-time video, set parameter, Video parameter, Video control, PTZ control, PTZ Configure and log out of the system. Figure 4-2 is shown the main page layout. Table 4-1 lists the elements on the main page layout.

Figure 4-2 Main page layout







Table 4-1 Elements on the main page

No.	Element	Description
1	Real-time video area	Real-time videos are played in this area. You can also set sensor parameters.
2	Playback	You can query the playback videos in this area. NOTE Only when the SD card or NAS have videos that user can query

No.	Element	Description
		the playback videos.
3	Device configuration	You can choose a menu to set device parameters, including the device information, audio and video streams, alarm setting, and privacy mask function.
4	Change password	You can click  to change the password.
5	Sign Out	You can click  to return to the login page.
6	Stream	There are three streams. Choose one type from drop-down list.
7	Pause/Start	Close live video or play live video.
8	Live/Smooth	Switch image quality.
9	Audio	Open or close audio.
10	Interphone	Open or close interphone.
11	Sensor setting	Click the icon, it will access to sensor setting.
12	Snapshot	Click the icon, it will snapshot.
13	Local record	Click the icon, it will record video and save.
14	Intelligent analysis	Open or close intelligent analysis.

 **NOTE**

1. When the device generates an alarm, the alarm icon  is displayed. You can click  to view the alarm information. When the device accepts an alarm signal, the alarm icon will display within 10s in the web management system.
2. When the device encounters an exception, the fault icon  is displayed. You can click  to view the fault information.

----End

4.1.3 Change the Password

Description

You can click  to change the password for logging in to the system.

Procedure

Step 1 Click  in the upper right corner of the main page.

The **Change Password** dialog box is displayed, as shown in Figure 4-3.

Figure 4-3 Modify Password dialog box

Change Password

Old Password

New Password

Confirm

Password Advice:

1. Advice the password length of eight characters.
2. Advice the password includes numbers, capital letters, lowercase letters and special characters.
3. Advice the password can not be the same as username.

OK Cancel

 **NOTE**

The change password page will be displayed if you don't change the default password when you login the system for the first time.

- Step 2 Enter the old password, new password, and confirmation password.
- Step 3 Click **OK**.

If the message "Change own password success" is displayed, the password is successfully changed. If the password fails to be changed, the cause is displayed. (For example, the new password length couldn't be less than eight.)

- Step 4 Click **OK**.
- The login page is displayed.
- End

4.1.4 Browse Video

User can browse the real-time video in the web management system.

Preparation

To ensure the real-time video can be play properly, you must perform the following operation when you login to the web for the first time:

- Step 1 Open the Internet Explorer. **Choose Tools > Internet options > Security > Trusted sites > Sites.**
- In the display dialog box, click **Add**, as shown in Figure 4-4.

Figure 4-4 Adding the a trusted site

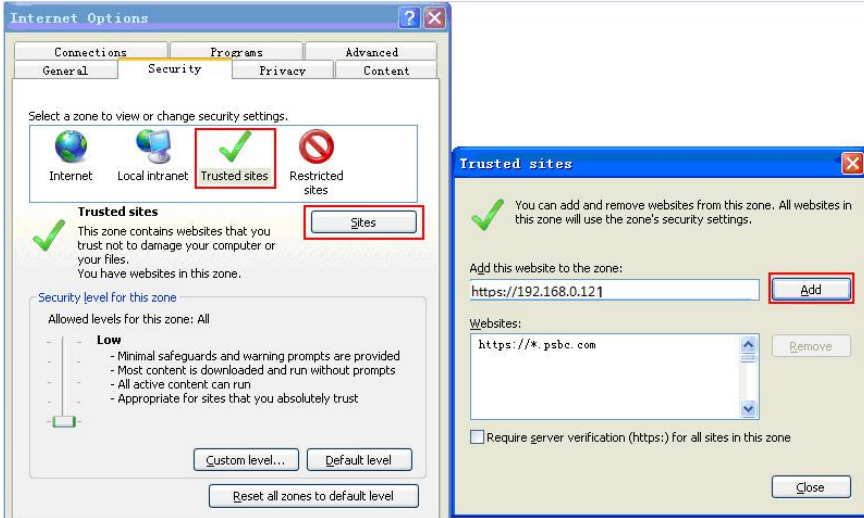

Step 2 In the Internet Explorer, choose **Tool > Internet Options > Security > Customer level**, and set **Download unsigned ActiveX control and initialize and script ActiveX controls not marked as safe for scripting under ActiveX controls and plug-ins** to **Enable**, as shown in Figure 4-5.

Figure 4-5 Configuring ActiveX control and plug-ins

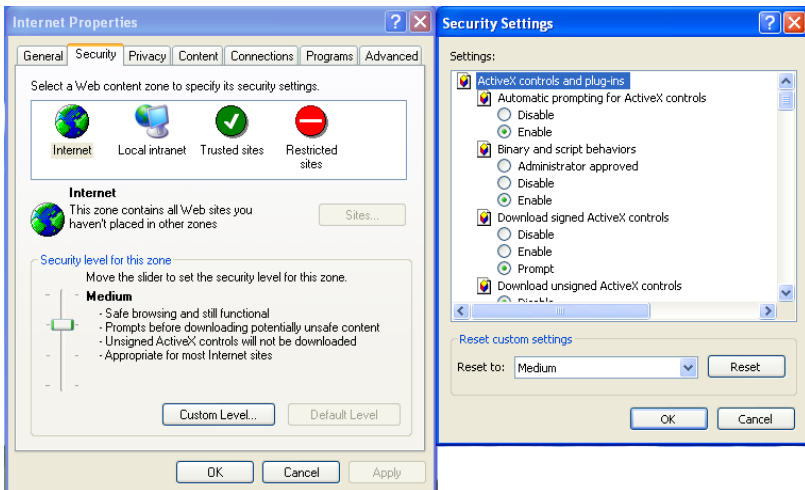

Step 3 Download and install the player control as prompted.

 **NOTE**

The login page is display when the control is loaded.

4.1.5 Install Plugins

You will be prompted with a message “Download and install the new plugin” as shown in Figure 4-6 when you login to the web management system for the first time.

Figure 4-6 Download the plugin page

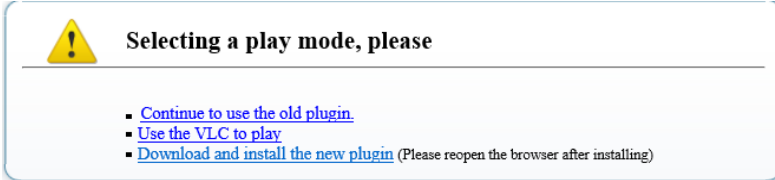

Procedure

Step 1 Click the message, download and install the plugin follow the prompts.

Step 2 Reopen the browser after installation.

----End

4.1.6 Set Local Network Parameters

Description

Local network parameters include:

- IP protocol
- IP address
- Subnet mask
- Default gateway
- Dynamic Host Configuration Protocol (DHCP)
- Preferred Domain Name System (DNS) server
- Alternate DNS server
- MTU

Procedure

Step 1 Choose **Configuration > Device >Local Network**.

The **Local Network** page is displayed, as shown in Figure 4-7.

Figure 4-7 Local Network page

Step 2 Set the parameters according to Table 4-2.

Table 4-2 Local network parameters

Parameter	Description	Setting
IP Protocol	IPv 4 is the IP protocol that uses an address length of 32 bits.	[Setting method] Select a value from the drop-down list box. [Default value] IPv 4
DHCP	The device automatically obtains the IP address from the DHCP server.	[Setting method] Click the option button. NOTE To query the current IP address of the device, you must query it on the platform based on the device name.
DHCP IP	IP address that the DHCP server assigned to the device.	N/A
IP Address	Device IP address that can be set as required.	[Setting method] Enter a value manually. [Default value] 192.168.0.120

Parameter	Description	Setting
Subnet Mask	Subnet mask of the network adapter.	[Setting method] Enter a value manually. [Default value] 255.255.255.0
Default Gateway	This parameter must be set if the client accesses the device through a gateway.	[Setting method] Enter a value manually. [Default value] 192.168.0.1
Preferred DNS Server	IP address of a DNS server.	[Setting method] Enter a value manually. [Default value] 192.168.0.1
Alternate DNS Server	IP address of a domain server. If the preferred DNS server is faulty, the device uses the alternate DNS server to resolve domain names.	[Setting method] Enter a value manually. [Default value] 192.168.0.2
MTU	Set the maximum value of network transmission data packets.	[Setting method] Enter a value manually. NOTE The MTU value is range from 800 to 1500, the default value is 1500, Please do not change it arbitrarily.

Step 3 Click **OK**.

- If the message "Apply success" is displayed, click **OK**. The system saves the settings. The message "Set network param's success, Please login system again" is displayed. Use the new IP address to login to the web management system.
- If the message "Invalid IP Address", "Invalid Subnet Mask", "Invalid default gateway", "Invalid primary DNS", or "Invalid space DNS" is displayed, set the parameters correctly.

 **NOTE**

- If you set only the **Subnet Mask**, **Default Gateway**, **Preferred DNS Server**, and **Alternate DNS Server** parameters, you do not need to login to the system again.
- You can click **Reset** to set the parameters again if required.

----End

4.1.7 Thermal Settings

4.1.7.1 Temperature Parameters

Temperature parameters include: temperature unit, ambient type, ambient temperature, cavity temperature, correctional coefficient and area temperature display mode.

Operation Procedure

Step 1 Choose **Configuration >Thermal >Temperature Parameters**.

The **Temperature Parameters** page is displayed, as shown in Figure 4-8.

Figure 4-8 Temperature Parameters interface

Temperature Parameters

Open Temperature Measure

Temperature Unit Celsius

Ambient Temperature 25.00

Cavity Temperature 33.54

Correction Coefficient 0.00

Area Temperature Display Mode Low Left

Font Border OFF

Custom Colors OFF

Area Temperature Type Highest Temperature

Measure Mode General

Display Alarm Area OFF

Area Alarm Interval(1-1800S) 10

Temperature Range -40.0 ~ 150.0

Advanced

Refresh Apply

Step 2 Set the parameters according to Table 4-3.

Table 4-3 Temperature parameters

Parameter	Description	Setting
Temperature Unit	Celsius and Fahrenheit temperature units are available.	[Setting method] Select a value from the drop-down list box. [Default value] Celsius

Parameter	Description	Setting
Ambient Temperature	The ambient temperature of camera. It is set when ambient is outside.	[Setting method] Enter a value manually.
Cavity Temperature	The cavity temperature of camera.	N/A
Correction Coefficient	Correction coefficient is refer to the deviation of measured object temperature and actual temperature. For example: 1. The measured object temperature is 30, and actual temperature is 37, so the correction coefficient should be 7 . 2. The measured object temperature is 37, and actual temperature is 30, so the correction coefficient should be -7 .	[Setting method] Enter a value manually. [Default value] 0.00
Area Temperature Display Mode	The display position of temperature information on the live-video image.	[Setting method] Select a value from the drop-down list box. [Default value] Low left
Font Border	Enable to bold the font	[Setting method] Enable or disable [Default value] Disable
Custom Colors	Enable to custom the color, there are nine colors chosen.	[Setting method] Enable or disable [Default value] Disable
Area Temperature Type	There are three types of area temperature.	[Setting method] Select a value from the drop-down list box. [Default value] Highest Temperature

Parameter	Description	Setting
Measure Mode	There are two types measure modes.	[Setting method] Select a value from the drop-down list box. [Default value] General
Display Alarm Area	N/A	[Setting method] Enable or disable [Default value] Disable
Area Alarm Interval	N/A	[Setting method] Enter a value manually ranges from 1 to 1800. [Default value] 10

Figure 4-9 Advanced interface



Table 4-4 Advance parameters

Parameter	Description	Setting
Dimming Mode	There are auto and manual modes. It will show on temperature item.	[Setting method] Select a value from the drop-down list box. [Default value] Auto

Parameter	Description	Setting
Greater Prominent	Enable that, the image will show the setting color if the temperature is higher than set value.	[Setting method] Enter a value manually. Choose one color to show.
Section Prominent	Enable that, the image will show the setting color if the temperature is between minimum and maximum temperature.	[Setting method] Enter a value manually. Choose one color to show.
Less Prominent	Enable that, the image will show the setting color if the temperature is lower than set value.	[Setting method] Enter a value manually. Choose one color to show.

Step 3 Click **Apply**.

The message "Apply success" is displayed, the system saves the settings.

----End

4.1.7.2 Temperature Area

Operation Procedure

Step 1 Choose **Configuration > Thermal > Temperature Area**.

The **Temperature Area** page is displayed, as shown in Figure 4-10

Figure 4-10 Temperature area and alarm configuration



Step 2 Set the parameters according to Table 4-5

Table 4-5 Temperature area and alarm configuration

Parameter	Description	Setting
Channel	N/A	[Setting method] Select a value from the drop-down list box. [Default value] 1
Measure Mode	Set at temperature parameter interface.	N/A
Enable	Tick to enable the areas	N/A
ID	It ranges from 0 to 19	N/A
Name	Area name of temperature area.	[Setting method] Enter a value manually.
Type	Type of temperature area. ID 0 is default rectangle area, which is full screen.	[Setting method] Select a value from the drop-down list box. [Default value] Rectangle/Point

Parameter	Description	Setting
Alarm Type	Threshold alarm, Section Alarm and Temperature difference alarm are available for alarm type.	[Setting method] Select a value from the drop-down list box. [Default value] Threshold alarm
Warning Value	Camera will warn when the surveillance object temperature reaches the warning value. At threshold alarm type and difference alarm type can be set.	[Setting method] Enter a value manually. [Default value] 48.00
Alarm Value	Camera will alarm when the surveillance object temperature reaches the alarm value.	[Setting method] Enter a value manually. [Default value] 50.00
Maximum Alarm Value	At section alarm type, the device would not alarm when the temperature is higher than maximum alarm value.	[Setting method] Enter a value manually. [Default value] 60.00
Emission Rate	The emission rate is the capability of an object to emit or absorb energy. The emission rate should be set only when the target is special material. The emission rate list refers to B Common Emission Rate	[Setting method] Enter a value manually. [Default value] 0.95
Distance(M)	The distance between camera and target.	[Setting method] Enter a value manually. [Default value] 15  NOTE Enter actual distance when the distance between camera and target is less than 15 m. Enter 15 when the distance between camera and target is great than or equal to 15 m.

Parameter	Description	Setting
Alarm	Open or close the alarm output and linkage of area.	[Setting method] Tick the alarm areas

Step 3 Set temperature area.

1. Tick an area ID.
2. Select type from drop-list.
3. Press and hold the left mouse button, and drag in the video area to draw a temperature area, as shown in Figure 4-11. Right-click to finish the area selected.

Figure 4-11 Temperature Area Setting Interface



4. Click **Apply**, the message “Apply success” is displayed, the temperature area is set successfully.

Delete a temperature area:

5. Select an area ID.
6. Click the temperature area and right-click.
7. Remove the tick of area ID.
8. Click **Apply**, the message “Apply success” is displayed, the temperature area is deleted successfully.

Step 4 Click Apply.

The message "Apply success" is displayed, the system saves the settings.

---End

4.1.7.3 Shield Area

Shield area is meaning that the camera will not to detect the temperature of that area.

Operation Procedure

Step 1 Choose **Configuration >Thermal > Shield Area.**

Figure 4-12 Shield Area

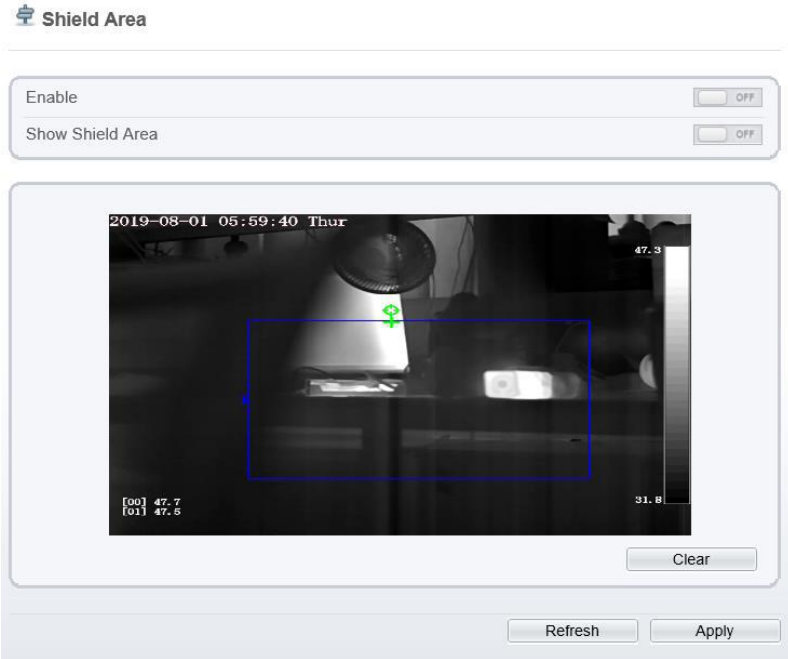

Step 2 Enable the shield area.

Step 3 Enable **Show Shield Area**, then the setting shield will show on live video.

Step 4 Click left mouse button to set area, click right mouse button to end the setting.

Step 5 Click **Clear** to clear the shield area.

----End

4.1.7.4 Schedule Linkage

Operation Procedure

Step 1 Choose **Configuration >Thermal > Schedule Linkage**

The **Schedule Linkage** page is displayed, as shown in Figure 4-13.

Figure 4-13 Schedule Linkage

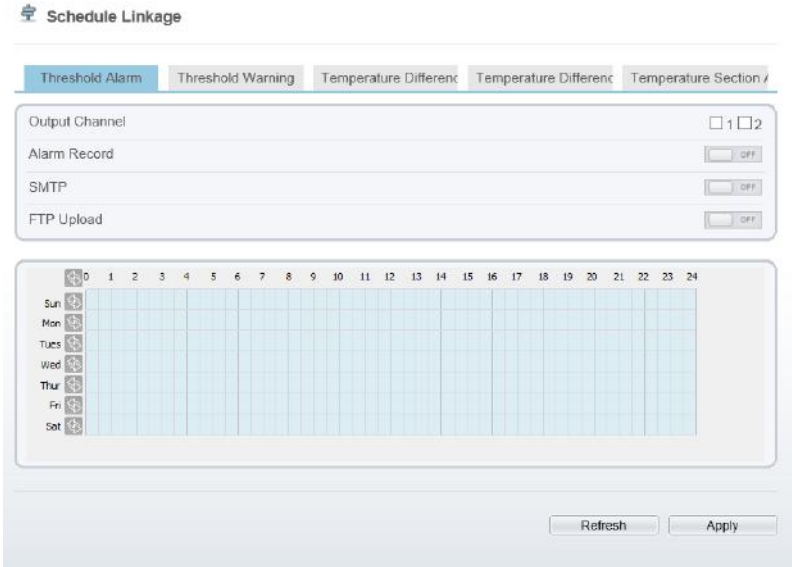

Step 2 Tick the output channel.

Step 3 Enable “Alarm Record”, “SMTP”, “FTP” button.

Step 4 Set schedule linkage.

Method 1: Click left mouse button to select any time point within 0:00-24:00 from Monday to Sunday as shown in Figure 4-13.

Method 2: Hold down the left mouse button, drag and release mouse to select the alarm time within 0:00-24:00 from Sunday to Saturday.

 **NOTE**

When you select time by dragging the cursor, the cursor cannot be moved out of the time area. Otherwise, no time can be selected.

Method 3: Click  in the alarm time page to select the whole day or whole week.

Deleting alarm time: Click  again or inverse selection to delete the selected alarm time.

Step 5 Click **Apply**.

The message "Apply success" is displayed, the system saves the settings.

---End

4.1.7.5 Bad Point Check

Description

The points that can't move when the environment or scenario change is bad point. You can delete the bad point by bad point check function.

Procedure

Step 1 Choose **Configuration > Thermal > Bad Point Check**

The **Bad Point Check** page is displayed, as shown in Figure 4-14.

Figure 4-14 Bad Point Check



Step 2 Click the white point at image, click **Apply** to recover the bad point, as shown in Figure 4-15

Figure 4-15 Recover bad point



Step 3 Click **Reset** to return the previous settings.

Step 4 Click **Apply**. The message "Apply success" is displayed, the system saves the settings.

----End

4.2 Visible-light Web

4.2.1 Login and Logout



CAUTION

You must use Internet Explorer 8 or a later version to access the web management system; otherwise, some functions may be unavailable.

Login system

Step 1 Open Internet Explorer, enter the IP address of the IP camera (default value: 192.168.0.120) in the address box, and press **Enter**.

The login page is displayed, as shown in Figure 4-16.

Figure 4-16 Login page



Step 2 Enter the user name, and password.



NOTE

- The default user name is admin. The default password is admin.
- Please change the password to ensure system security.
- You can change the system display language on the login page

Step 3 Click login.

The main page is displayed.

----End

Logout



To log out of the system, click  in the upper right corner of the main page. The login page is displayed after you log out of the system.



4.2.2 Main Page Layout





On the main page, you can view real-time videos, receive alarm and fault notifications, set parameters, change the password, and log out of the system. Figure 4-17 shows the main page layout. Table 4-6 describes the elements on the main page.

Figure 4-17 Main page layout



Table 4-6 Elements on the main page

No.	Element	Description
1	Real-time video area	Real-time videos are played in this area. You can also set sensor parameters.
2	Playback	You can query the playback videos in this area. NOTE Only when the SD card or NAS have videos that you can query the playback videos.
3	Device configuration	You can choose a menu to set device parameters, including the device information, audio and video streams, alarm setting, and privacy mask function.
4	Alarm icon	When the device generates an alarm, the alarm icon  is displayed. You can click  to view the alarm information. NOTE When the device accepts an alarm signal, the alarm icon will display within 10s in the web management system.

No.	Element	Description
5	Fault icon	When the device encounters an exception, the fault icon  is displayed. You can click  to view the fault information.
6	Change password	You can click  to change the password.
7	Sign Out	You can click  to return to the login page.

----End

4.2.3 Change the Password

Description

You can click  to change the password for logging in to the system.

Procedure

Step 1 Click  in the upper right corner of the main page.

The **Change Password** dialog box is displayed, as shown in Figure 4-18.

Figure 4-18 Modify Password dialog box

Change Password [X]

Old Password

New Password

Confirm

Password Advice:
1. Advice the password length of eight characters.
2. Advice the password includes numbers, capital letters, lowercase letters and special characters.
3. Advice the password can not be the same as username.

OK Cancel

NOTE

The change password page will be displayed if you don't change the default password when you login the system for the first time. User need to wait at least three minutes after changing password, and then restart the device. The password incorrect more than 3 times, please login again after 5 minutes. Enter the old password, new password, and confirmation password.

Step 2 Click **OK**.

If the message "Change own password success" is displayed, the password is successfully changed. If the password fails to be changed, the cause is displayed. (For example, the new password length could not be less than eight.)

Step 3 Click **OK**.

The login page is displayed.

----**End**

4.2.4 Browse Video

User can browse the real-time video in the web management system.

Preparation

To ensure that real-time videos can be played properly, you must perform the following operations when you login to the web management system for the first time:

Step 1 Open Internet Explorer. Choose **Tools > Internet Options > Security > Trusted sites > Sites**.

In the displayed dialog box, click **Add**, as shown in Figure 4-19.

Figure 4-19 Add a trusted site

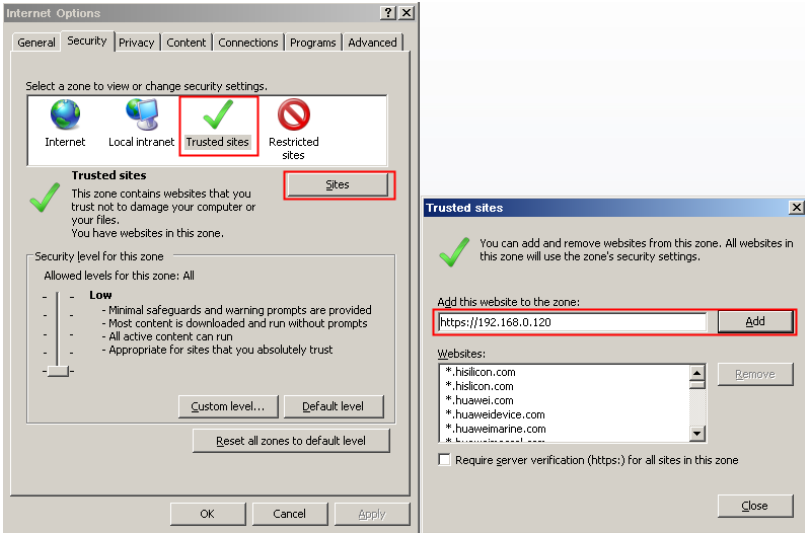

Step 2 In Internet Explorer, choose Tools > Internet Options > Security > Customer level, and set Download unsigned ActiveX controls and Initialize and script ActiveX controls not marked as safe for scripting under ActiveX controls and plug-ins to Enable, as shown in Figure 4-20.

Figure 4-20 Configure ActiveX controls and plug-ins

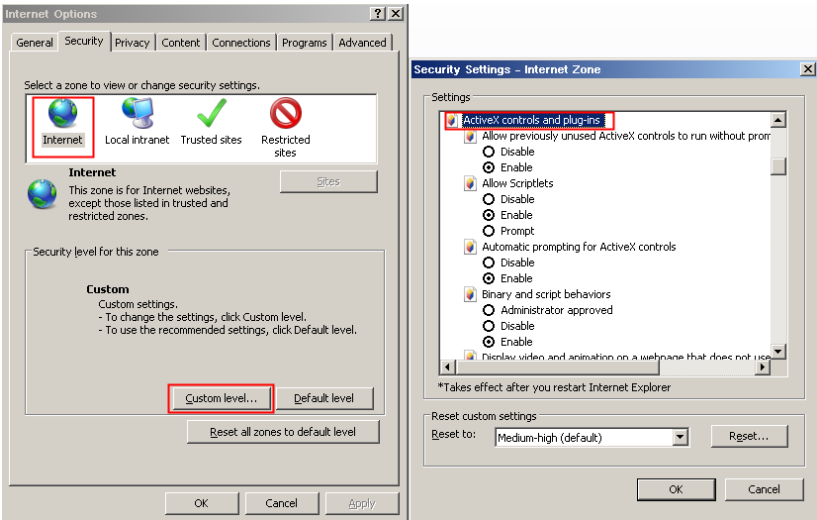

Step 3 Download and install the player control as prompted.

 **NOTE**

If the repair tips displayed when installing the control, please ignore the prompt, and continue the installation, the login page is displayed when the control is loaded.

Download the right control in the Internet Explorer

Real-time video page pop-ups the message **clicks to play live video with ActiveX control to reduce latency**.

Click the message, jump to download ActiveX control interface, once downloading is complete, you can watch more fluent video screen.

Unable to display video picture, and need to download and install the control

Real-time video page pop-up the message **click to download the latest version of Flash Play live video** and **click to play video with ActiveX control to reduce latency**.

Click the message **click to play live video with ActiveX control to reduce latency**, jump download Adobe Flash Player Plugin control interface, once downloading is complete, you can watch video screen.

Click the message **click to download the latest version of Flash Play live video**, jump to download ActiveX control interface, once downloading is complete, you can watch more fluent video screen.

In the Google, Firefox, or Safari browsers watch real-time video

Google, Firefox, and Safari browsers only support Adobe Flash Player Plugin to play video. When Adobe Flash Plugin control version is too low, browser will automatically clew you to download the latest control.

----End

4.2.5 Set Local Network Parameters

Description

Local network parameters include:

- IP protocol
- IP address
- Subnet mask
- Default gateway
- Dynamic Host Configuration Protocol (DHCP)
- Preferred Domain Name System (DNS) server
- Alternate DNS server

- MTU

Procedure

Step 1 Choose **Configuration > Device > Local Network**.

The **Local Network** page is displayed, as shown in Figure 4-21

Figure 4-21 Local Network page

Local Network

Network Card ID: 1

IP Protocol: IPv4

DHCP: OFF

IP Address: 192.168.32.151

Subnet Mask: 255.255.255.0

Default Gateway: 192.168.32.1

Preferred DNS Server: 202.96.128.86

Alternate DNS Server: 202.96.134.133

MTU(800-1500): 1500

Refresh Apply

Step 2 Set the parameters according to Table 4-7.

Table 4-7 Local network parameters

Parameter	Description	Setting
IP Protocol	IPv 4 is the IP protocol that uses an address length of 32 bits.	[Setting method] Select a value from the drop-down list box. [Default value] IPv 4

Parameter	Description	Setting
Obtain IP address automatically	The device automatically obtains the IP address from the DHCP server.	[Setting method] Click the button on to enable DHCP . NOTE To query the current IP address of the device, you must query it on the platform based on the device name.
DHCP IP	IP address that the DHCP server assigned to the device.	N/A
IP Address	Device IP address that can be set as required.	[Setting method] Enter a value manually. [Default value] 192.168.0.120
Subnet Mask	Subnet mask of the network adapter.	[Setting method] Enter a value manually. [Default value] 255.255.255.0
Default Gateway	This parameter must be set if the client accesses the device through a gateway.	[Setting method] Enter a value manually. [Default value] 192.168.0.1
Preferred DNS Server	IP address of a DNS server.	[Setting method] Enter a value manually. [Default value] 192.168.0.1
Alternate DNS Server	IP address of a domain server. If the preferred DNS server is faulty, the device uses the alternate DNS server to resolve domain names.	[Setting method] Enter a value manually. [Default value] 192.168.0.2

Parameter	Description	Setting
MTU(800-1500)	Set the maximum value of network transmission data packets.	[Setting method] Enter a value manually. NOTE The MTU value is range from 800 to 1500, the default value is 1500, Please do not change it arbitrarily.

Step 3 Click **Apply**.

- If the message "Apply succeed!" is displayed, click Confirm. The system saves the settings. The message "Set network parameter success, Please login system again" is displayed. Use the new IP address to login to the web management system.
- If the message "Invalid IP Address", "Invalid Subnet Mask", "Invalid default gateway", "Invalid primary DNS", or "Invalid space DNS" is displayed, set the parameters correctly.

----End

5 Thermal Parameter Configuration

5.1 Access the Sensor Setting Interface

Operation procedure:

- Step 1 On the web interface or client interface, move the cursor to the real-time video page and right-click on the page. A shortcut menu is displayed, as shown in Figure 5-1, and Table 5-1 describes the sensor setting interface.

Figure 5-1 Sensor Setting interface

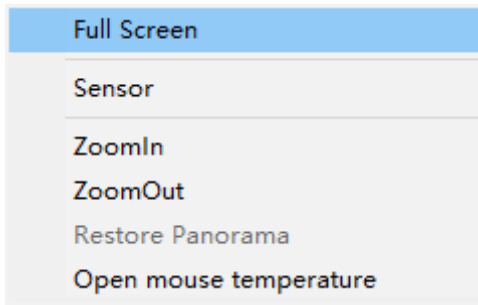

Table 5-1 Sensor Setting interface

Parameter	Description
Full Screen	It enlarges and displays the image in full screen.
Hide Info	It refers to the function that hides the IP address, code rate and other information of the functioning imaging device on the Client Side. Note: This function is only applicable to the Client Side and not for the WEB Side.
Sensor Configure	It is used for configuring the parameter set of front-end images.
Zoom In/Out	It zooms in/out images by electronic means. This function may also be used with the mouse wheel.
Open mouse temperature	Click this, and mouse cursor display temperature of point that cursor's position.

Step 2 Choose **Sensor Configure** and the **Sensor Setting** dialog box appears.

----End

5.2 Sensor Setting Parameter description

5.2.1 Time Segment

Operation procedure:

Step 1 Click **Time Segment** tag on sensor setting interface, the time segment page is displayed, as shown in Figure 5-2.

Figure 5-2 Time Segment page

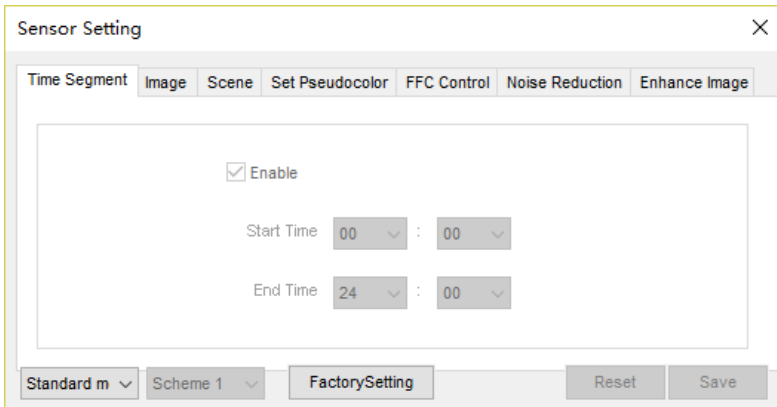

Step 2 Choose Debug Model in the lower left corner to activate the sensor setting page.

Step 3 Set the time segment parameters.

Step 4 Click save to save the setting.

----End

5.2.2 Image Setting

Figure 5-3 shows the image setting interface.

Figure 5-3 Image setting interface

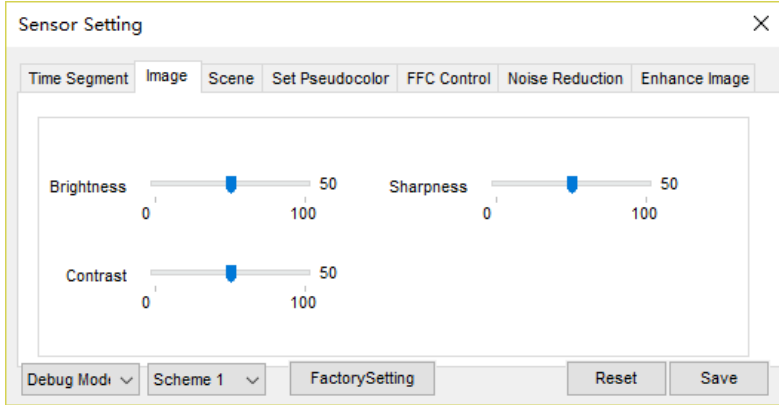

Table 5-2 describes the image setting parameters.

Table 5-2 Image setting parameter description

Parameter	Description	Setting
Brightness	It indicates the total brightness of an image. As the value increases, the image becomes brighter.	[Setting method] Drag the slider. [Default value] 50
Contrast	It indicates the contrast between the bright part and the dark part of an image. As the value increases, the contrast increases.	[Setting method] Drag the slider. [Default value] 50
Sharpness	It indicates the sharpness of the image plane and the sharpness of the image edge. The sharper the image, the better detail contrast.	[Setting method] Drag the slider. [Default value] 50

----End

5.2.3 Scene

Figure 5-4 shows the scene interface.

Figure 5-4 Scene interface

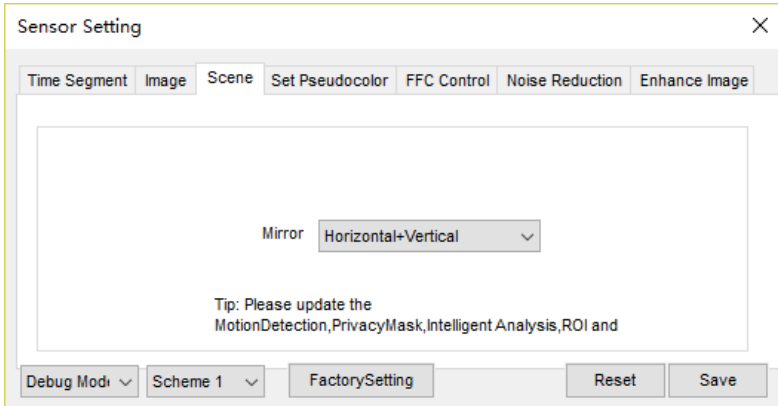

Provide the selection of image pixel locations.

Normal: the image is not flipped.

Horizontal: the image is flipped left and right.

Vertical: the image is flipped up and down.

Horizontal + Vertical: the image upside-down and reversal.

5.2.4 Set Pseudocolor

Figure 5-5 shows the set pseudocolor interface.

Figure 5-5 set pseudocolor interface

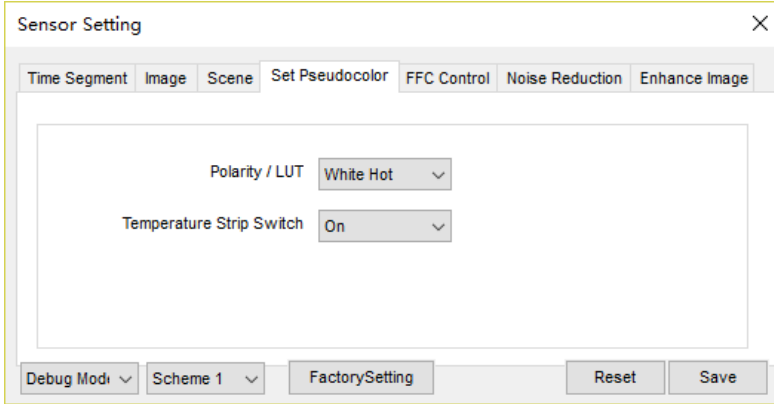

Polarity/LUT: the temperatures of the temperature fields detected by the thermal imaging camera are separately mapped to values ranging from 0 to 255 by the algorithm. In the black/white display mode, this range is converted to the grayscale tones. For example, 0 indicates completely black, and 255 indicates completely white. The temperature field of the scene is converted to images by using the grayscale images. Different polarity modes can be converted to different display images. The most common setting is white hot (a hotter object is displayed brighter than a colder object) or black hot (a hotter object is displayed darker than a colder object). The difference between two modes lies in that the temperatures corresponding to the darker one and the lighter one are reversed. Other modes include rainbow, ironbow, HSV, autumn, bone and so on.

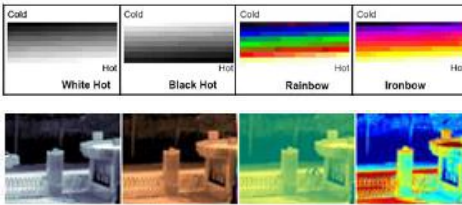

Temperature strip switch is on, the live video will show it, otherwise is no strip.

5.2.5 FFC Control

Figure 5-6 shows the FFC mode interface.

Figure 5-6 FFC mode interface

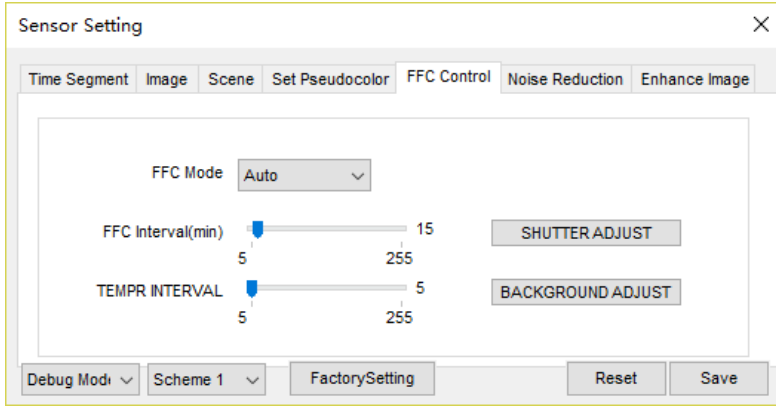

Table 5-3 describes the FFC mode parameters.

Table 5-3 FFC control parameter description

Parameter	Description	Setting
FFC Mode	<p>The internal of the thermal imaging camera may comprise the mechanical action correction mechanism that can periodically improve the image quality. This component is called flat field correction (FFC). When controlling the FFC, the FFC shields the sensor array, so that each portion of the sensor can collect uniform temperature fields (flat field). By means of FFC, the camera can update the correction coefficients to output more uniform images. Throughout the FFC process, the video image is frozen for two seconds and a static-frame image is displayed. After the FFC is complete, the image is automatically recovered. Repeated FFC operations can prevent the grainy and image degradation problems. The FFC is especially important when the temperature of the camera changes. For example, after the camera is powered on or the ambient temperature is changed, you should immediately perform the FFC.</p> <p>Auto: In the Automatic FFC mode, the camera performs FFC whenever its temperature changes by a specified amount or at the end of a specified period of time (whichever comes first). When this mode is selected, the FFC interval (minutes) ranges from 5 to 30 minutes. The temperature</p>	<p>[How to set] Select from the drop-down list box. [Default value] Auto</p>

Parameter	Description	Setting
	<p>change of the camera is based on the temperatures collected by the internal temperature probe. The temperature of the camera sharply changes when the camera is powered on. The FFC is relatively frequent, which is normal.</p> <p>Manual: In the manual FFC mode, the camera does not automatically perform the FFC based on the temperature change or the specified period. You can press the Do FFC button to select the manual FFC mode. When you feel that the image is obviously degraded but the automatic FFC is not performed, you can use the manual FFC function to check whether the image quality can be improved.</p>	
FFC Interval (min)	In the automatic FFC mode, the FFC interval ranges from 5 to 255 minutes.	[How to set] Drag the slider. [Default value] 5
Temper Interval	In the automatic FFC mode, the FFC interval ranges from 5 to 25.5 centigrade.	[How to set] Drag the slider. [Default value] 5
Shutter Adjust	Click the icon to adjust exposure immediately.	N/A
Background Adjust	Click the icon and cover the camera with something to adjust image. Remove the thing to finish adjustment.	N/A

----End

5.2.6 Noise Reduction

Figure 5-7 shows the Noise reduction interface.

Figure 5-7 Noise reduction interface

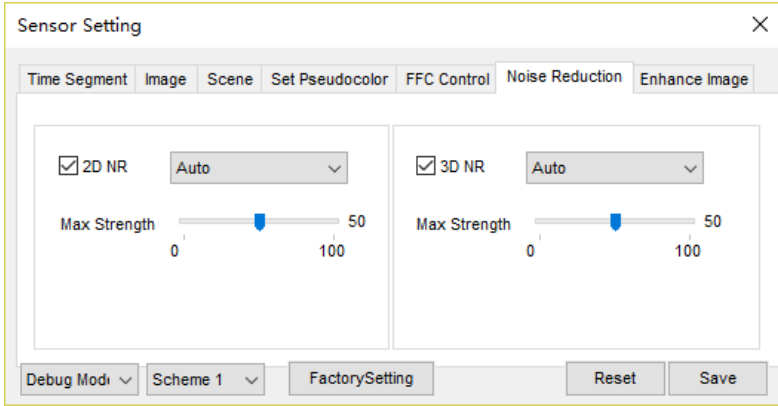

Table 5-4 describes noise reduction parameters.

Table 5-4 DNR parameter description

Parameter	Description	Setting
2 DNR	Decrease the image noise.	[How to set] Select from the drop-down list box. Drag the slider to adjust max strength. [Default value] Auto
3 DNR	Decrease the image noise.	[How to set] Select from the drop-down list box. Drag the slider to adjust max strength. [Default value] Auto

----End

5.2.7 Enhance Image

Figure 5-8 shows the screen adjustment interface and Table 5-5 shows the screen adjustment parameter..

Figure 5-8 Enhance image interface

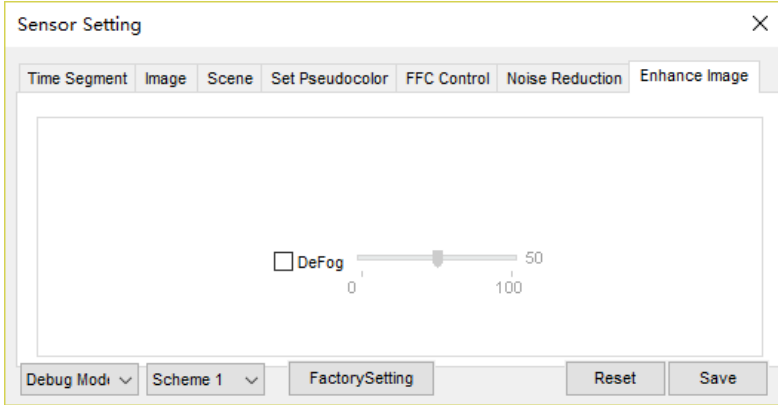

Table 5-5 Screen adjustment parameter description

Parameter	Meaning	Configurati on Method
Mode selection	<p>Compared with images generated based on visible light, IR images boast the features of high background and low contrast. In an IR image, background radiation occupies a big part of dynamic display scope and the target object occupies less dynamic display scope. If this object emits weak IR ray, it will be submerged among the dark background and difficult to be identified. To resolve the problem, the IR image must be enhanced and preprocessed. The thermal imaging camera allows an image mode to be preset according to the temperature distribution differences of a specific environment or scenario so as to highlight the object:</p> <ul style="list-style-type: none"> • Outdoor • Indoor • Sky/Earth • Sea/Sky • Linear • Common • Custom 	<p>[Configurati on method] Select from the drop-down list [Default value] Sky/Earth</p>

Parameter	Meaning	Configuration Method
Contrast	It indicates the contrast between the bright part and the dark part of an image. As the value increases, the contrast increases.	[Configuration method] Drag the slide bar [Default value] 120
Brightness	It indicates the total brightness of an image. As the value increases, the image becomes brighter.	[Configuration method] Drag the slide bar [Default value] 240

----End

6 Visible-light Parameter Configuration

6.1 Access the Sensor Interface

Operation procedure

Step 1 On the web or NVMS interface, move the cursor to the real-time video page and right-click on the page. A shortcut menu is displayed, as shown in Figure 6-1.

Figure 6-1 Sensor Setting interface

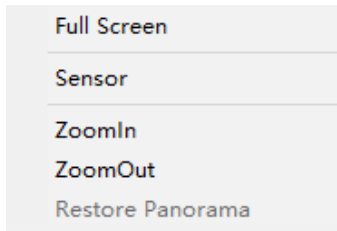

Step 2 Choose **Sensor Configure** and the **Sensor Setting** dialog box appears.

----End

6.2 Sensor Setting Parameter description

6.2.1 Time Segment

Operation procedure:

Step 1 Click **Time Segment** tag on sensor setting interface, the time segment page is displayed, as shown in Figure 6-2.

Figure 6-2 Time Segment page

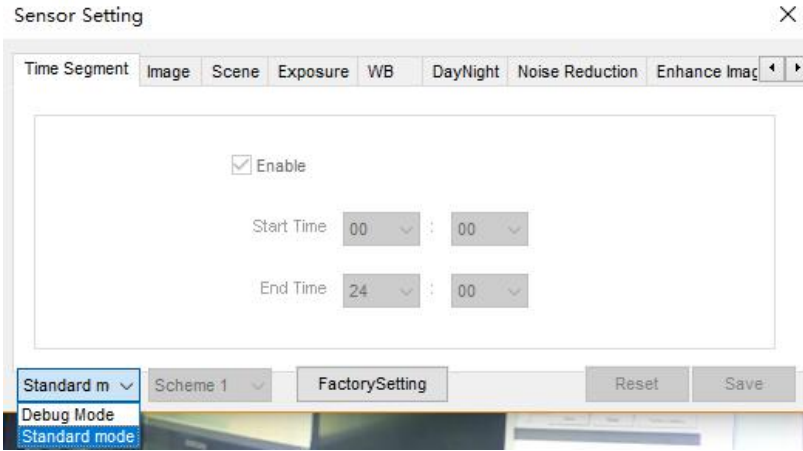

- Step 2 Choose Debug Model in the lower left corner to activate the sensor setting page.
 - Step 3 Set the time segment parameters.
 - Step 4 Click save to save the setting.
- End

6.2.2 Image Adjust

Figure 6-3 shows the Image Adjust tab page.

Figure 6-3 Image Adjust tab page

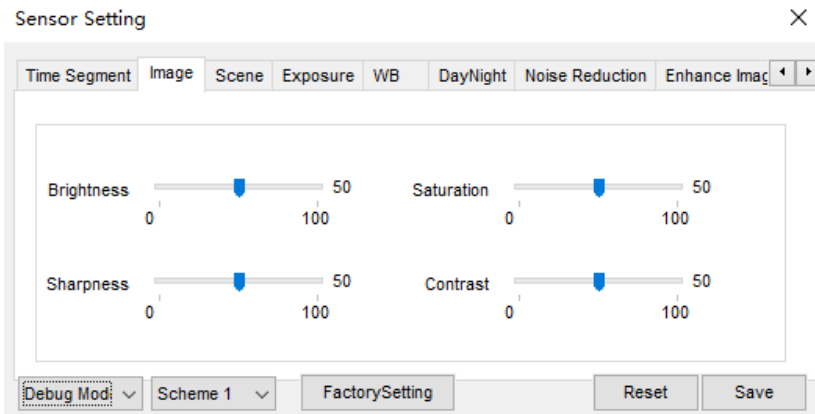

Table 6-1 describes the parameters on the Image Adjust tab page.

Table 6-1 Parameters on the Image Adjust tab page

Parameter	Description	Configuration Method
Contrast	It indicates the contrast between the bright part and the dark part of an image. As the value increases, the contrast increases.	[Setting method] Drag the slider. [Default value] 50
Brightness	It indicates the total brightness of an image. As the value increases, the image becomes brighter.	[Setting method] Drag the slider. [Default value] 50
Sharpness	It indicates the border sharpness of an image. As the value increases, the borders become clearer, and the number of noise points increases.	[Setting method] Drag the slider. [Default value] 50
Saturation	It indicates the color saturation of an image. As the value increases, the image becomes more colorful.	[Setting method] Drag the slider. [Default value] 50

----End

6.2.3 Scene Mode

Figure 6-4 shows the scene mode interface.

Figure 6-4 Scene mode interface

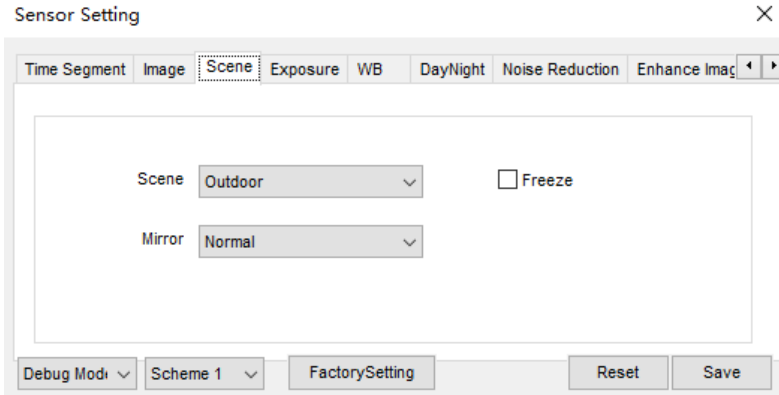

Table 6-2 describes the FFC mode parameters.

Table 6-2 FFC mode parameters description

Parameter	Description	Configuration Method
Scene	It indicates the working mode of a camera.. <ul style="list-style-type: none"> Outdoor: It applies to outdoor scenarios. Indoor: It applies to indoor scenarios. 	[Configuration method] Select from the drop-down list [Default value] Outdoor
Mirror	It is used to select the pixel location of an image. <ul style="list-style-type: none"> Normal: The image does not flip. Horizontal: The image flips to the left and right. Vertical: The image flips up and down. Horizontal and vertical: The image rotates at 180 degrees. 	[Setting method] Select a value from the drop-down list. [Default value] Normal
Freeze	It can be set to on or off . It is used to enable or disable the image freezing function of a camera.	[Setting method] Tick the Freeze status. [Default value] Disable

6.2.4 Exposure

Figure 6-5 shows the Exposure interface.

Figure 6-5 Exposure interface for high speed dome

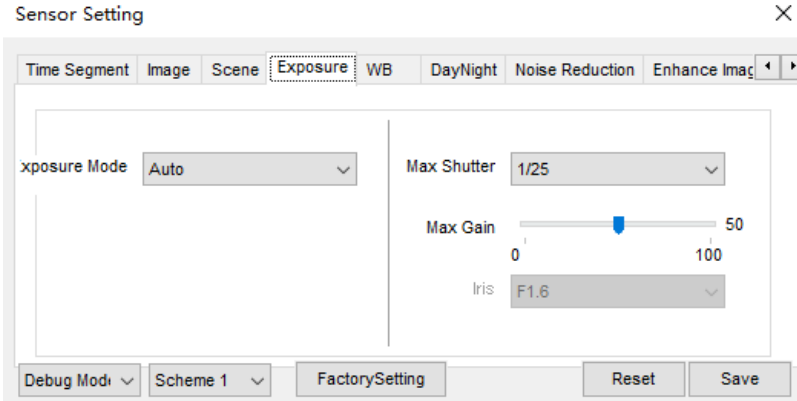

Table 6-3 describes Exposure parameters.

Table 6-3 Exposure parameters description

Parameter	Meaning	Configuration Method
Exposure Mode	The exposure modes include: <ul style="list-style-type: none"> • Auto: The system performs auto exposure based on the monitoring environment. • Manual: You can adjust the brightness of an image by setting the following three items: Shutter Setting, Iris Setting and Gain Setting. • Shutter Priority: You can set Shutter Setting to fixed values. The iris and gain are automatically adjusted by the system. • Iris Priority (for high speed dome): You can set Iris Setting to fixed values. The shutter and gain are automatically adjusted by the system. 	[Setting method] Select a value from the drop-down list. [Default value] Auto

Parameter	Meaning	Configuration Method
Max Shutter	The device automatically adjusts the shutter time based on the ambient brightness. The shutter time is less than or equal to the value of this parameter.	[Setting method] Select a value from the drop-down list. [Default value] 1/25
Max Gain	The device automatically adjusts the gain based on the external light. The gain is less than or equal to the value of this parameter.	[Setting method] Drag the slider. [Default value] 50
Iris (for high speed dome)	It is valid in manual mode and iris priority mode. You can adjust the brightness of an image by setting the iris. As the value increases, the brightness increases (when the shutter and gain remain the same). However, the camera movement automatically adjusts the shutter and gain in this mode. Therefore, the brightness of an image may not increase when you increase the iris.	[Setting method] Select a value from the drop-down list. [Default value] F1.6

6.2.5 WB Setting

Figure 6-6 shows the **WB Setting** interface.

Figure 6-6 WB Setting interface

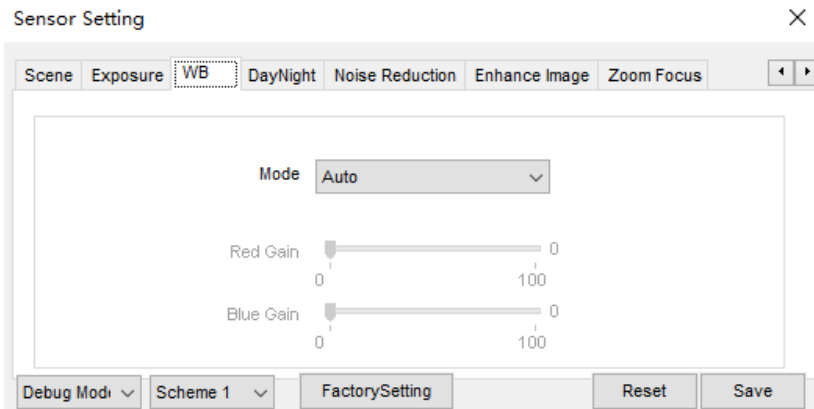



Table 6-4 describes **WB Setting** parameters.

Table 6-4 **WB** Setting parameters description

Parameter	Meaning	Configuration Method
Mode	<p>It is adjusted based on application scenarios to improve the fidelity of the image color.</p> <p>The WB modes include:</p> <ul style="list-style-type: none"> • Auto: In automatic white balance (WB) mode, the system automatically performs white balance based on the monitoring environment. • Tungsten • Fluorescent • Daylight • Shadow • Manual: In manual WB mode, you can manually select a WB mode based on the monitoring environment. 	<p>[Setting method] Select a value from the drop-down list. [Default value] Auto</p>
Red Gain	<p>It indicates the gain applied to red channels. As the value increases, the color temperature becomes lower.</p> <p> NOTE This parameter is valid when Manual Mode is set to Customized.</p>	<p>[Setting method] Drag the slider. [Default value] 0</p>
Blue Gain	<p>It indicates the gain applied to blue channels. As the value increases, the color temperature becomes higher.</p> <p> NOTE This parameter is valid when Manual Mode is set to Customized.</p>	<p>[Setting method] Drag the slider. [Default value] 0</p>

6.2.6 Daynight

The day night mode settings vary based on device models. For details, see the following sections.

Figure 6-7 shows the **DayNight Mode** interface.

Figure 6-7 DayNight Mode interface

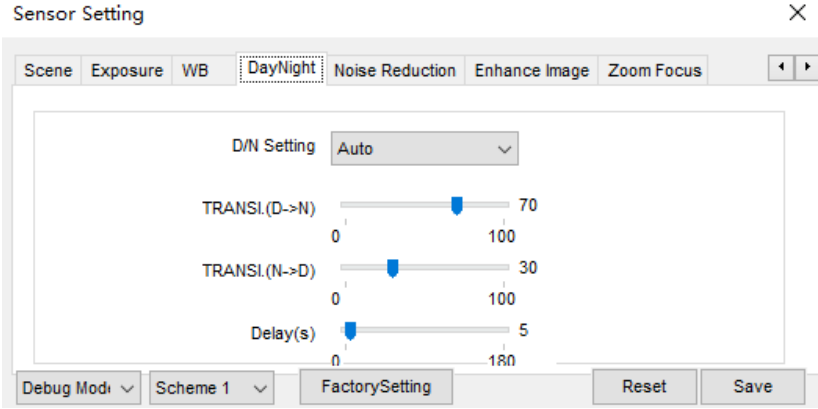





Table 6-5 describes **DayNight Mode** parameters.

Table 6-5 DNR parameters description

Parameter	Meaning	Configuration Method
<p>D/N Setting Mode</p>	<p>It can be set to Auto, Day, Night or Timing.</p> <ul style="list-style-type: none"> • Auto mode The image color and filter status are automatically switched based on the ambient brightness. The filter prevents infrared light from entering the sensor in the day state and allows all types of light to enter the sensor in the night state. • Day mode The image is colored, and the filter is in the day state, preventing infrared light from entering the sensor. • Night mode The image is black and white, and the filter is in the night state, allowing infrared light to enter the sensor. • Timing Set day to night time and night to day time to switch the daynight mode. 	<p>[Setting method] Select a value from the drop-down list. [Default value] Auto</p>
<p>TRANSL.(D->N)(dB)</p>	<p>It determines the day-to-night switching in auto mode. When the system gain is greater than the value of this parameter, the system enters the night mode.</p> <p> NOTE This parameter is valid in auto mode. The value of TRANSL.(D->N) must be greater than the value of TRANSL.(N->D).</p>	<p>[Setting method] Drag the slider. [Default value] 70</p>

Parameter	Meaning	Configuration Method
TRANSL.(N->D)(dB)	<p>It determines the night-to-day switching in auto mode. When the system gain is smaller than the value of this parameter, the system enters the day mode.</p> <p> NOTE This parameter is valid in auto mode. The value of TRANSL.(D->N) must be greater than the value of TRANSL.(N->D).</p>	<p>[Setting method] Drag the slider. [Default value] 30</p>
Delay(s)	<p>The delay time of day to night or night to day.</p> <p> NOTE This parameter is valid in auto mode.</p>	<p>[Setting method] Drag the slider. [Default value] 0</p>
DTN Time	Time of day to night.	<p>[Setting method] Select a value from the drop-down list. [Default value] 18:00</p>
NTD Time	Time of night to day.	<p>[Setting method] Select a value from the drop-down list. [Default value] 6:00</p>

6.2.7 Noise Reduction

Figure 6-8 shows the Noise Reduction interface.

Figure 6-8 Noise Reduction interface

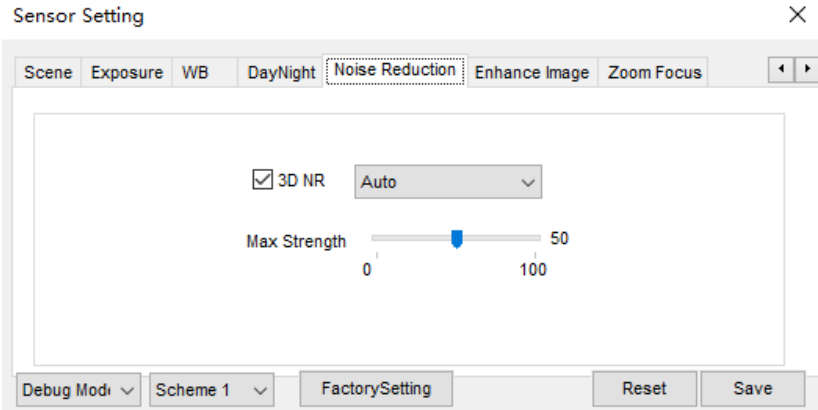

Table 6-6 describes DNR parameters.

Table 6-6 DNR parameters description

Parameter	Meaning	Configuration Method
3D NR	Reduce noise of image.	[Configuration method] Select from the drop-down list [Default value] Auto
Max Strength	It is valid in auto noise filter mode. When the parameter value is 0, the noise filter is disabled. When the parameter value is greater than 0, the noise filter is enabled, and the system automatically adjusts the noise filter level based on the ambient brightness without exceeding the value of this parameter.	[Setting method] Drag the slider. [Default value] 50

6.2.8 Enhance Image

Figure 6-9 shows the enhance image interface and Table 6-7 shows the enhance image parameter.

Figure 6-9 Enhance image interface

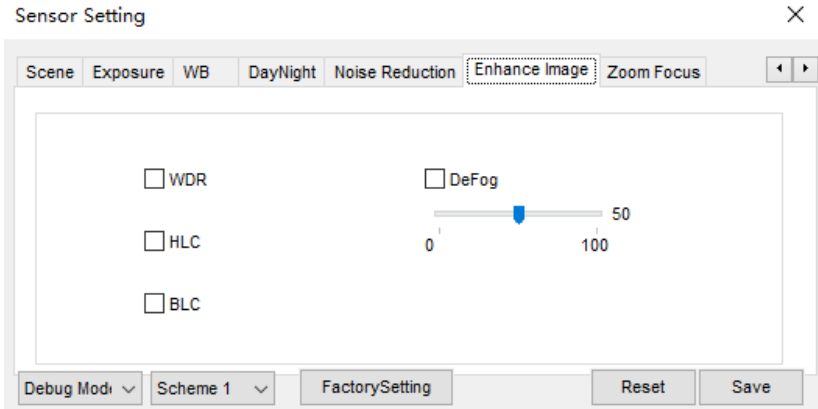

Table 6-7 Enhance image parameters description

Parameter	Meaning	Configuration Method
WDR	It is used to display the foreground and background at the same time in the environment with a large brightness difference. When the brightness difference is larger, you can increase the WDR level to obtain better image effect.	[Setting method] Tick the WDR mode and drag the slider. [Default value] 50
HLC	It provides a clearer view of an image in the highlight environment. When HLC is enabled, the total brightness of an image is reduced, allowing you to view objects in front of the highlight.	[Setting method] Tick the HLC mode and drag the slider. [Default value] 50
BLC	It provides a clearer view of an image in the backlight environment. When BLC is enabled, the total brightness of an image increases, allowing you to view objects in front of the backlight. Meanwhile, the objects behind the backlight are exposed excessively.	[Setting method] Tick the BLC mode.

Parameter	Meaning	Configuration Method
DeFog	It provides a clearer view of an image in the fogged environment when Defog is enabled. As the value increases, the image becomes clearer.	[Setting method] Tick the Defog mode and drag the slider. [Default value] 50

6.2.9 Zoom Focus

Figure 6-10 shows the zoom focus interface and Table 6-8 shows the zoom focus parameter.

Figure 6-10 Zoom focus interface for high speed dome

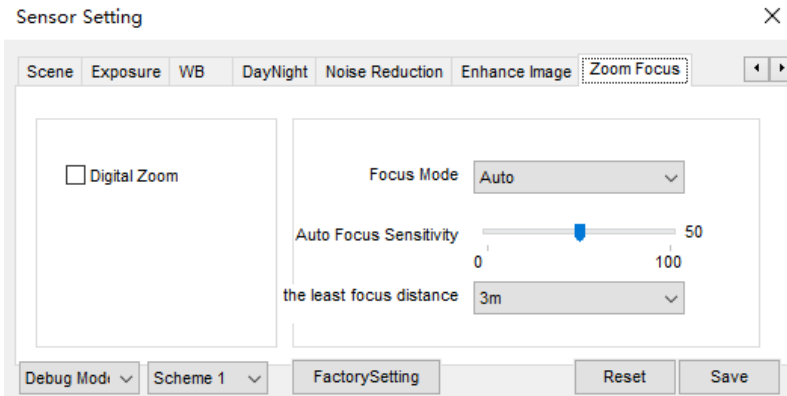



Table 6-8 Zoom focus parameters description

Parameter	Meaning	Configuration Method
Digital	This function enables digital zoom after an image is zoomed in by 20 times in optical mode.	[Setting method] Tick the Digital.

Parameter	Meaning	Configuration Method
Focus Mode	<p>It can be set to the auto, manual or semi-automatic mode.</p> <p>Auto focus mode: The system automatically triggers focus based on application scenarios.</p> <p>Manual focus mode: You can trigger focus by using the buttons on the client.</p> <p>Semi-automatic focus mode: The system only automatically trigger focus once when the PTZ move or zoom in a scene.</p>	<p>[Configuration method] Select from the drop-down list [Default value] Semi-automatic</p>
Auto Focus Sensitivity	<p>It indicates the sensitivity of auto focus. When the sensitivity is high, the camera movement is more likely to focus again at slight changes of an image.</p>	<p>[Setting method] Drag the slider. [Default value] 50</p>
The least focus distance	<p>It indicates the minimum focus distance. A camera does not focus when the distance is smaller than this value. For example, if the minimum focus distance is set to 1.5 m, a camera focuses only on objects more than 1.5 m away, and the changes of objects less than 1.5 m away do not affect the focusing.</p> <p> NOTE</p> <p>This parameter applies only to visible light.</p>	<p>[Configuration method] Select from the drop-down list [Default value] 6 m</p>

----End

7 PTZ Function Application

7.1 PTZ Control function

Operation Description

PTZ Control function is only available to a camera with an external PTZ and High Speed Dome with PTZ function.

PTZ Control

When browsing real-time videos shot by a dome camera or a camera connected to an external PTZ, you can control the PTZ to view Video shot in different directions.





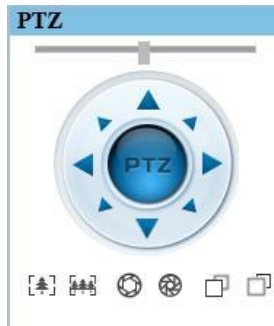

In the PTZ control area, you can click the eight arrow keys to move the PTZ in eight directions, as shown in Figure 7-1.

Figure 7-1 PTZ Control zone



It may also control the iris, zoom and focus of the camera lens through other buttons in the PTZ control zone. Functions of each button are as shown in Table 7-1.

Table 7-1 Descriptions of PTZ buttons

Button	Description
Auto Zoom	Click  or  to adjust the surveillance range of the front-end lens.
Auto Iris	Click  or  to adjust the size of the front-end iris.
Auto Focus	Click  or  to adjust the focus of the front-end lens.
Speed	Drag the slider on  to adjust the rotational speed of the PTZ.

----End

7.2 PTZ configuration

7.2.1 PTZ setting

Click , the PTZ configuration interface displayed, as shown in Figure 7-2.

Figure 7-2 PTZ Configuration



Through this interface, you can perform the following operations:

- Add, Delete and Apply a Preset, Track, Scan and Tour.
- Set and enable Idle.
- Set the direction to due north.
- Any direction can be set as the reference due north.
- Configure Timer.

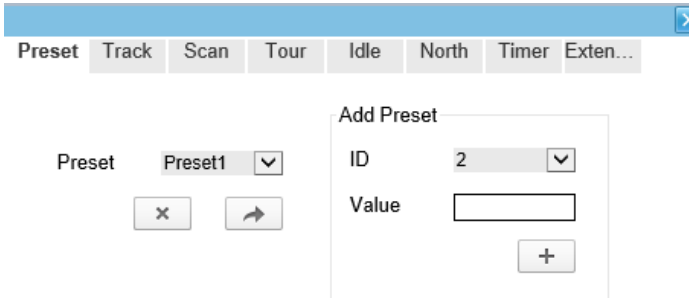
----End

7.2.2 Configure and Apply Preset



You can configure preset positions and quickly rotate the camera to preset position by applying the preset.

Operation procedure

- Step 1 Click **Preset** tab page in the PTZ configuration interface, the add preset page is displayed, as shown in Figure 7-3.

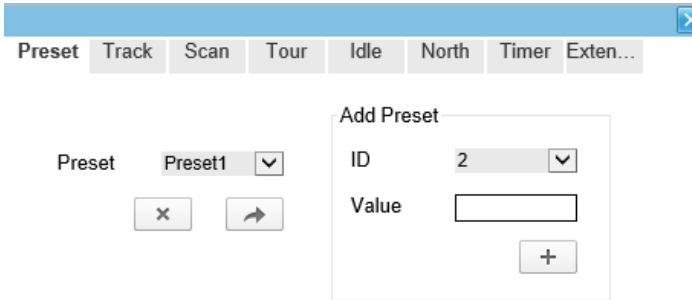
Figure 7-3 Add Preset



- Step 2 Select a preset ID (such as 1) from the Preset drop-down list box and enter the name of preset.
- Step 3 Use eight arrow keys in the **PTZ control** area to configure a position, then click  to complete adding a preset.
- Step 4 Select a Preset name from the Preset drop-down list box and click  to apply the preset.

NOTE

Up to 255 Presets can be configured

----End

7.2.3 Configure and Apply Tracks

You can record a track to allow the camera to repeatedly rotate based on the preset track.



Operation procedure

- Step 1 Click **Track** tab page in the PTZ configuration interface, the add track page is displayed as shown in Figure 7-4.

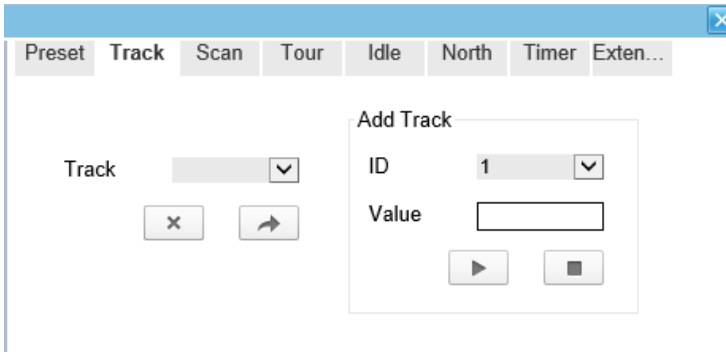
Figure 7-4 Add Track



Step 2 Select a track ID (such as 1) from the track drop-down list box and enter the name of track.

Step 3 Click , then use eight arrow keys in the **PTZ control** area to configure a track, then click  to complete adding a track.

Step 4 Select a Track name from the Track t drop-down list box and click  to apply the track.

 **NOTE**

Up to 6 Tracks can be configured.

----End

7.2.4 Configure and Apply Scan



You can configure a Scan to rotate the camera between two positions by applying the Scan.

Operation procedure

Step 1 Click **Scan** tab page in the PTZ configuration interface, the add Scan page is displayed, as shown in Figure 7-5.

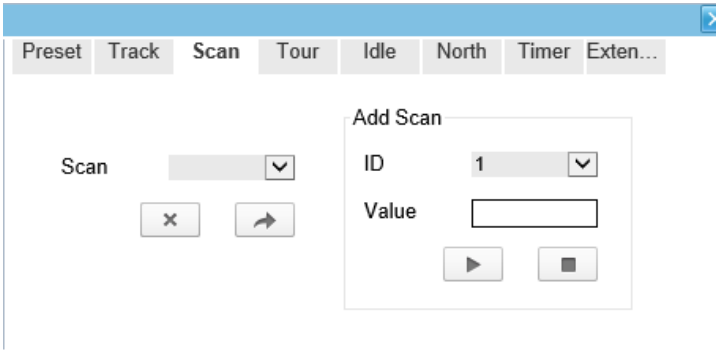
Figure 7-5 Add Scan



- Step 2 Select Scan ID (such as 1) from the track drop-down list box and enter the name of scan.
 - Step 3 Click , then use eight arrow keys in the **PTZ control** area to configure two positions, then click  to complete adding a scan.
 - Step 4 Select a Scan name from the Scan t drop-down list box and click  to apply the scan.
- End

7.2.5 Configure and Apply Tour





You can configure a tour to rotate the camera between presets set by PTZ.

Operation procedure

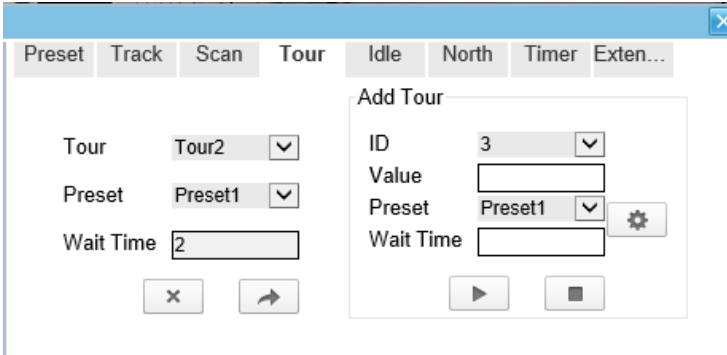
- Step 1 Click **Tour** tab page in the PTZ configuration interface, the add tour page is displayed, as shown in Figure 7-6.

Figure 7-6 Add Tour



- Step 2 Select Tour ID (such as 2) from the drop-down list box, enter the tour name.
- Step 3 Select first required position preset from the **preset** drop-down list box.
- Step 4 Input the values from **Wait Time** area box to set the time to stay in this position preset.(0 sec~ 255 sec).
- Step 5 Click  button to begin setting tour.
- Step 6 Click  in the add tour page; select next position preset form the preset drop-down list box, and then input the values from Wait Time area box to set the time to stay in next position preset.(0 sec~ 255 sec).
- Step 7 Repeat former step until all required position presets are completed adding.
- Step 8 Click  to complete adding a tour (You also can click Cancel button to quit current setting).
- Step 9 Select a tour name and preset from the tour and preset drop-down list box, and then click  to apply the tour.

----End

7.2.6 Configure and Apply Idle



You can configure an idle to `apply preset. Scan, Track, or Tour regularly.

Operation procedure

- Step 1 Click **Idle** tab page in the PTZ configuration interface, the idle page is displayed, as shown in Figure 7-7.

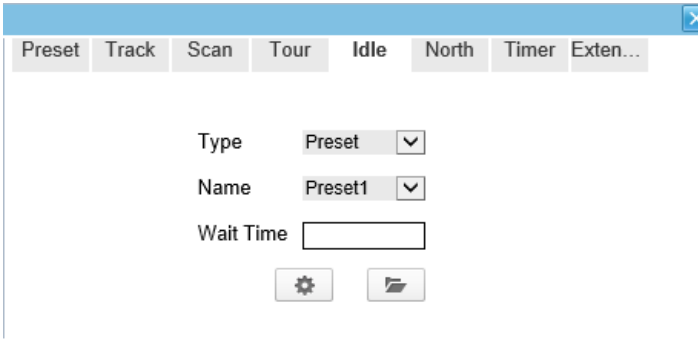
Figure 7-7 Idle



- Step 2 Select a monitor type from the **Type** drop-down list box. Monitor type can choose preset, Scan, track, tour and Cir Scan.
 - Step 3 Select a name form the **Name** drop-down list box.
 - Step 4 Input a value from the **Wait Time** area box.
 - Step 5 Click  to completed adding an idle.
 - Step 6 Click  to enable idle function.
- End

7.2.7 Configure North

Operation procedure

- Step 1 Click **North** tab page in the PTZ configuration interface, the north page is displayed as shown in Figure 7-8.

Figure 7-8 North

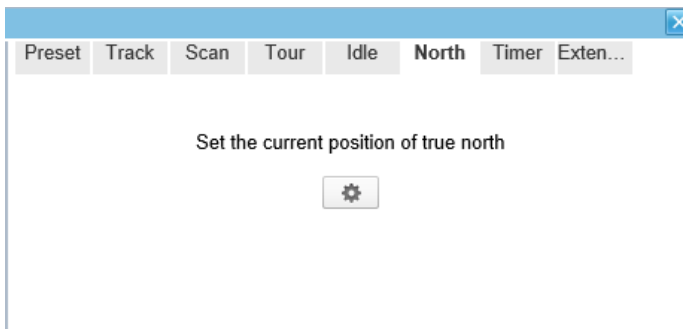

Step 2 Click  to set the current position of true north.

----End

7.2.8 Configure Timer

Operation procedure

Step 1 Click **Timer** tab page in the PTZ configuration interface, the set timer page is displayed, as shown in Figure 7-9.

Figure 7-9 Set Timer

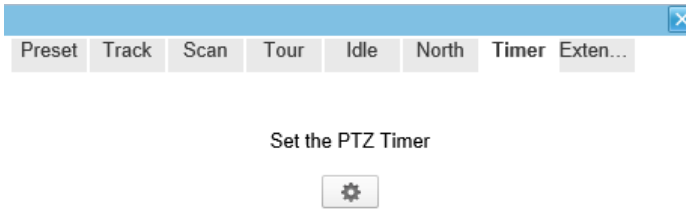

Step 2 Click , the Timer page is displayed, as shown in Figure 7-10.

Figure 7-10 Timer



Step 3 Check **Enable** box.

Step 4 Select the timer mode.

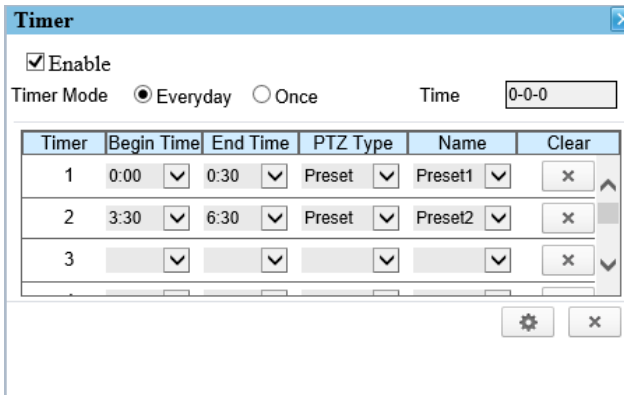
Step 5 Select the required begin time at the **Begin Time** drop-down list box, and then select the required end time at the **End Time** drop-down list box.

- Step 6 Select the required monitor type at the PTZ type drop-down list box, you can select preset, Scan, Track, Tour in the box, and then select a specific from the **Name** drop-down list box.(for example preset, 1).
 - Step 7 Repeat Step 5 and Step 6 to add more required time.
 - Step 8 Click  to complete timer setting.
- End

7.2.9 Configure Extension



You can use extension function including lamp and brush.

Operation procedure

- Step 1 Click **Extension** tab page in the PTZ configuration interface, the extension page is displayed, as shown in Figure 7-11.

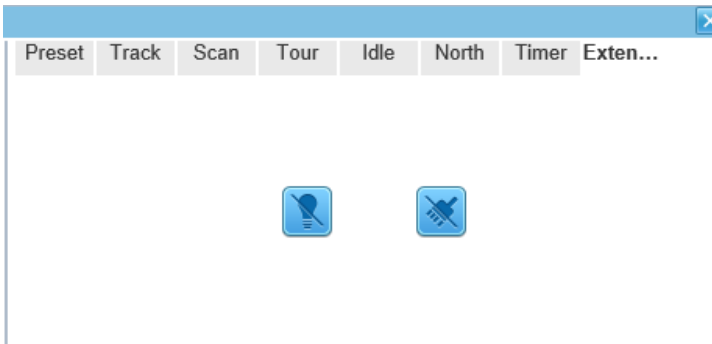
Figure 7-11 Extension



- Step 2 Click  to enable the lamp.
Light On/Off is used to control the infrared camera shields on and off. It's available only to specific camera shields.
 - Click  to enable the brush.
Brush is used to clean the lens. It's available only to a camera with a brush or a camera shield.
- End

A Troubleshooting

Common Trouble	Possible Cause	Solution
Unable to access the web	Network is not connected.	<ul style="list-style-type: none">• Connect the network cable of the camera to the PC to check whether the network cable is in good contact.• Run the ping command to check the network connection and whether the device works normally.
	IP address is occupied.	Directly connect the camera to the PC, and reset the IP address of the camera.
	The IP addresses of the PC and the device are in different networks.	Check the IP address, subnet mask and gateway setting of the camera.
PTZ or high speed dome is out of control.	The protocol, bit-rate, or address setting of the PTZ is incorrect.	Modify the address of the PTZ on the web.
	The signal cable is unconnected or not connected correctly.	Check the signal strength, and reconnect the signal cable.
The measured temperature is not accurate.	The device is just powered on, and the temperature of the cavity is unstable.	The temperature of the cavity is stable within 15 to 30 min after the device is powered on.
	The FFC mode is incorrect.	The FFC mode is auto by default. If the mode is set to manual, it will be no block calibration, which may lead to fuzzy pictures and inaccurate temperature.
	The target configuration is incorrect.	Check whether the emission rate and distance of the target are configured correctly.

Common Trouble	Possible Cause	Solution
An error occurs in accessing the web of the device after the upgrade.	The data in the cache of browser is not updated in time.	<p>Delete the cache of the Internet Explorer. The steps are as follows (taking IE9 as an example):</p> <ol style="list-style-type: none"> 1. Open the Internet Explorer. 2. Select Tools > Internet Options. 3. On the General tab, select Delete under Browsing history. The Delete Browsing History dialog box appears. 4. Select all check boxes. 5. Click Delete. <p>Re-login the web page of the camera.</p>
Upgrade failed.	No network cable is connected.	Ensure the upgrade network is connected.
	The network setting is incorrect.	Check whether the network setting is correct.
	The upgrade package is incorrect.	Perform the correct upgrade package again.
No self-test no image output	There is a broken line in the circuit	Find breakpoints, rewiring.
	Low supply voltage	Replace the power adapter to increase the output voltage.
Self-test exception	Low supply voltage	Replace the power adapter to increase the output voltage.
Equipment control is normal, image instability (Analog video)	Poor video circuit contact	Troubleshooting, rewiring
	Access device exception	Replacement access device
Equipment control is	Network line bad contact	Dismantling bad point, re-wiring.

Common Trouble	Possible Cause	Solution
normal, image instability (Web video)	Access to computer performance is insufficient, take up CPU usage	Lower stream and resolution
	Lack of network bandwidth	Replacement of industrial Gigabit switches
	Access decoder performance decoder	Replacement of high-performance decoder
Self-test normal, can not control	Wrong wiring	Rewiring
	Set the baud rate, protocol, address and device mismatch	Screen configuration according to device parameters
Repeated restart	Insufficient supply voltage or voltage instability	To ensure that the input device voltage stability
Can not control the lens to perform zoom and Focus action	Wiring error	Re-connect the lens control line
	Circuit board lens control problems	Replacement circuit board (please contact after-sales rework processing, do not replace parts or repair)
Can not recall the set lens preset point	DIP switch relative to the set lens preset dialing is not set to ON	DIP switch control lens preset dialing dial into ON
The image is lost when the control device rotates	Rotation process at the same location lost image	Conductive slip ring there is a bad contact, replace the parts (please contact after-sales rework, do not replace parts or repair)

B Common Emission Rate

Emission Rate

The emission rate is the capability of an object to emit or absorb energy. An ideal transmitter provides an emission rate of emitting 100% of intake energy. An object with an emission rate of 0.8 can absorb 80% of intake energy, and reflect the remaining 20%. The emission rate is the ratio of the energy emitted by an object at a specific temperature to that emitted by an ideal radiator at the same temperature. The range of emission rate value is 0.0 to 1.0 generally.

Materials	Temperature (°C/°F)	Emissivity
Gold (High-purity)	227/440	0.02
Aluminum foil	27/81	0.04
Aluminum sheet	27/81	0.18
Aluminum used for families (flat)	23/73	0.01
Aluminum plate (98.3% purity)	227/440	0.04
	577/1070	0.06
Aluminum plate (rough)	26/78	0.06
Aluminum (oxidized @ 599°C)	199/390	0.11
	599/1110	0.19
Polished aluminum	38/1 0	0.22
Tin (light tinned Iron sheet)	25/77	0.04

Nickel wire	187/368	0.1
Lead (99.9% purity, No oxidized)	127/260	0.06
Copper	199/390	0.18
Cobalt	599/1110	0.19
Steel	199/390	0.5
	599/1110	0.57
Tinned iron sheet (Light)	28/82	0.23
Brass(High-polish)	247/476	0.03
Brass (Tough rolled, polished metal wire)	21/70	0.04
Tinned Iron (Light)	-	0.13
Iron plate (Rust eaten)	20/68	0.69
Rolled steel sheet	21/71	0.66
Ferric oxide	100/212	0.74
Wrought-iron	21/70	0.94
Fused iron	1299-1399/3270-2550	0.29
Copper (Polished)	21-117/70-242	0.02
Copper(Polished, not reflected)	22/72	0.07
Copper (Heavy oxide Board)	25/77	0.78
Enamel (Fuse on iron)	19/66	0.9
Formica Plate	27/81	0.94

Frozen soil	-	0.93
Brick (Red, rough)	21/70	0.93
Brick (Unglazed, rough)	1000/1832	0.8
Carbon (T - carbon 0.9% ash)	127/260	0.81
Concrete	-	0.94
Glass (Glossy)	22/72	0.94
Granite (Surfaced)	21/70	0.85
Ice	0/32	0.97
Marble (I Polished, grey)	22/72	0.93
Asbestos board	23/74	0.96
Asbestos paper	38/100	0.93
	371/700	0.95
Asphalt (Paving the road)	4/39	0.97
Paper (Black tar)	-	0.93
Paper (White)	-	0.95
Plastic (White)	-	0.91