

HD Video Recorder(XVR) Quick Setup Guide

NO.:101-600-0302-01
Issue:1.1

Precautions

Fully understand this document before using this device, and strictly observe rules in this document when using this device. If you install this device in public places, provide the tip "You have entered the area of electronic surveillance" in an eye-catching place. Failure to correctly use electrical products may cause fire and severe injuries.

WARNING	It alerts you for moderate dangers which, if not avoided, may cause minor or moderate injuries.
CAUTION	It alerts you about risks. Neglect of these risks may cause device damage, data loss, device performance deterioration, or unpredictable results.
NOTE	It provides additional information.

WARNING
 • Strictly observe installation requirements when installing the device. The manufacturer shall not be held responsible for device damage caused by users' non-conformance to these requirements.

• Strictly conform to local electrical safety standards and use power adapters that are marked with the LPS standard when installing and using this device. Otherwise, this device may be damaged.

• Use accessories delivered with this device. The voltage must meet input voltage requirements for this device.
 • If this device is installed in places with unsteady voltage, ground this device to discharge high energy such as electrical surges in order to prevent the power supply from burning out.

• When this device is in use, ensure that no water or any liquid flows into the device. If water or liquid unexpectedly flows into the device, immediately power off the device and disconnect all cables (such as power cables and network cables) from this device.

• If this device is installed in places where thunder and lightning frequently occur, ground the device nearby to discharge high energy such as thunder strikes in order to prevent device damage.

CAUTION

• Avoid heavy loads, intensive shakes, and soaking to prevent damages during transportation and storage. The warranty does not cover any device damage that is caused during secondary packaging and transportation after the original packaging is taken apart.

• Protect this device from fall-down and intensive strikes, keep the device away from magnetic field interference, and do not install the device in places with shaking surfaces or under shocks.

• Clean the device with a soft dry cloth. For stubborn dirt, dip the cloth into slight neutral cleanser, gently wipe the dirt with the cloth, and then dry the device.

• Do not jam the ventilation opening. Follow the installation instructions provided in this document when installing the device.

• Keep the device away from heat sources such as radiators, electric heaters, or other heat equipment.

• Keep the device away from moist, dusty, extremely hot or cold places.

• If the device is installed outdoors, take insect- and moisture-proof measures to avoid circuit board corrosion that can affect monitoring.

• Remove the power plug if the device is idle for a long time.

Special Announcement

• All complete products sold by the manufacturer are delivered along with nameplates, quick setup guide and accessories after strict inspection. The manufacturer shall not be held responsible for counterfeit products.

• The manufacturer will update this manual according to product function enhancement or changes and regularly update the software and hardware described in this manual. Update information will be added to new versions of this manual without prior notice.

• This manual may contain misprints, technology information that is not accurate enough, or product function and operation description that is slightly inconsistent with the actual product, the final interpretation of company is as a standard.

• This manual is only for reference and does not ensure that the information is totally consistent with the actual product. For consistency, see the actual product.

NOTE

For more information, please refer to website.

1 Open Package Examination

Open the package, check the appearance of product for no obvious damage, and confirm the item list for table 1-1 is consistent.

Table 1-1 Packing list

Component	Quantity	Remark
Network Video Recorder	1	
Quick Setup Guide	1	
Mouse	1	
Power adapter	1	Optional
Power cord	1	
Phillips head screw	12	
Terminal block	2	Optional

2 Device Structure

2.1 Device Ports

NOTE

Different devices may have different ports and multi-head cables; Please refer to the actual product.

Figure 2-1 Front panel

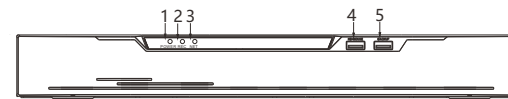

Front panel description of device, please refer to table 2-1.

Table 2-1 Front panel description

Port Name	Description
1 POWER Indicator	When the XVR is operating, the POWER indicator is steady on. When the XVR is shut down, the POWER indicator is turned off.
2 REC Indicator	Hard disk status indicator. This indicator flashes when data is transmitted.
3 NET Indicator	The network status indicator. This indicator flashes when network is working.
4 MOUSE	Supports connection to a USB mouse.
5 BACKUP	Supports connection to a USB flash drive or USB removable hard disk.

Rear panel description of device, please refer to table 2-2.

Table 2-2 Rear panel description

Name	Description
VIDEO IN Port	Plug in analog camera by coaxial line.
CVBS OUT	Output analog video signal.
AUDIO OUT/ AUDIO IN	Audio output / Audio input.
LAN	RJ 45 10 /100/1000 Mbps adaptive Ethernet interface.
HDMI	Video output interface.
VGA	
USB	USB 2.0 port, Connect USB flash or mouse.
Alarm I/O	Alarm input/Alarm output.
	Power switch.
	DC12V.
	Ground.

2.2 Device Dimensions

NOTE

Different devices may have different dimensions; Please refer to the actual product.

Figure 2-1 Dimensions (Unit:mm)

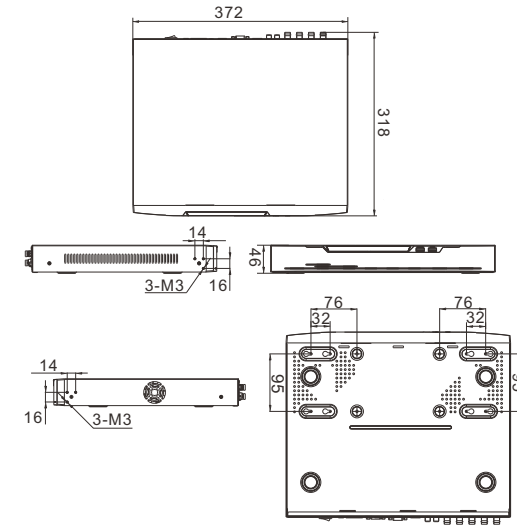

3 Device Installation

The hard disk of the XVR must be provided by the user. Take the following steps to install the hard disks:

Step 1 Remove the screws for fixing the cover and take down the cover.

Step 2 Take out the screws and mount two of them to the screw holes of hard disk, as shown in figure 3-1.

Figure 3-1 Installing the hard disk screws

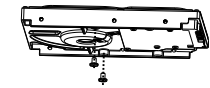

NOTE

• Just screw the screws about 1 to 2 turns instead to the end.

Step 3 Route the screws through the gourd holes on the base, push the hard disk to the appropriate position on the left, as shown in figure 3-2.

Step 4 Turn the device over, and mount other two screws to the holes, as shown in figure 3-3. Then fasten all the screws.

Figure 3-2 Installing hard disk **Figure 3-3** Fixing hard disk

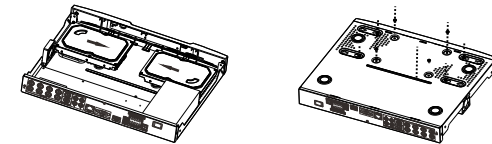

Step 5 Install other hard disks following step 2, step 3 and step 4, and insert the hard disk data cable and power cable, then replace the upper cover and fasten the fixing screws.

4 Device Operation

4.1 Startup

Before starting XVR, ensure that the XVR is connected to a power supply properly and a monitor is connected to the HDMI or VGA interface of the XVR correctly. After starting the XVR, there is a login window located in the center, as shown in figure 4-1 and 4-2.

CAUTION In some environments, if the power supply is abnormal, the XVR may not work properly. In severe cases, the XVR may be damaged. In these environments, it's advised to use regulated power supply.

Figure 4-1 Activation interface

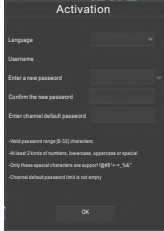
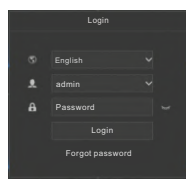

Figure 4-2 Login interface



NOTE

- User needs to create a new password to activate the device, when logging into for first time.
- User can also set pattern unlock to quickly login. Set security questions which are used for password recovery.
- Change the language in log in interface.

4.2 Topology of the XVR

XVR can access analog cameras immediately when analog cameras are plugged into XVR's VIDEO IN ports. Then the XVR will assign an IP address for each camera automatically. For the topology refer to figure 4-3.

Figure 4-3 Topology of the XVR

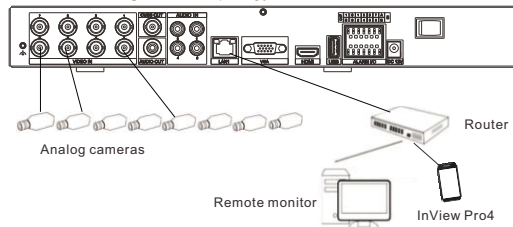

4.3 Special Function

Click the AI Recognition icon, Human Face, or Thermal Temperature at the bottom of local UI to enter the AI interface. User can set and view the AI cameras' parameters, including human face, vehicle license plate.

4.4 Power off

Enter the path **Main Menu > System > Maintenance > Shutdown** to power off the XVR.

NOTE

- Before replacing the hard disk, the power must be turned off.
- The special function is only carried by some devices, if the current device does not have the function, please ignore it.

5 Quick Configuration

Plug in power to access the XVR user page, the wizard window would show at first time, user can configure quickly or close it immediately. For details configuration please refer to main menu. Use the mouse to right-click any where on the main interface to access the main menu. Main menu comprises Channel, Record, Alarm, Network and System settings, as shown in figure 5-1.

5.1 Channel

Channel settings contain Camera, Encode, Sensor Setting, OSD, Privacy Zone, ROI, Microphone, Human Thermal, Smart, Intelligent Tracking.

- Camera:** user can add cameras automatically by clicking **Click to Add**, and add manually by clicking **Add**. Tick cameras then click **Delete** to delete cameras. User can batch update software.

Figure 5-1 Main menu

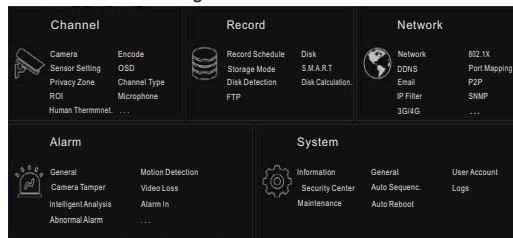

- Sensor Setting:** set the sensor parameter of channels' cameras.
- OSD/Privacy Zone/ROI:** set on live video screen.
- Channel Type:** set the analog channels' type, user can set AUTO/AHD/TVI/CVI/IP.
- Microphone:** adjust and set the microphone of channels.
- Human thermometer/ Smart/ Intelligent Tracking:** these functions are used for special function cameras, configure the parameters of cameras.
- All these settings can be copied to other channels by clicking **Copy** button.

5.2 Record

Record settings contain Record Schedule, Disk, Storage, Disk Calculation, SMART, Disk Detection, Disk Calculation and FTP. Set record schedule and storage strategic. User can calculate the disk's using time at **Disk Calculation** interface. Enter **S.M.A.R.T** interface to view the state of disks. **Disk Detection** can detect the disks. **FTP:** set the parameters of FTP upload, the alarm video can be sent to FTP path.

5.3 Alarm

Alarm settings contain General, Motion detection, Camera Tamper, Video loss, Intelligent analysis, Alarm in, Abnormal alarm, Alarm out, Local Intelligent Analysis, as shown in figure 5-2

Figure 5-2 Alarm

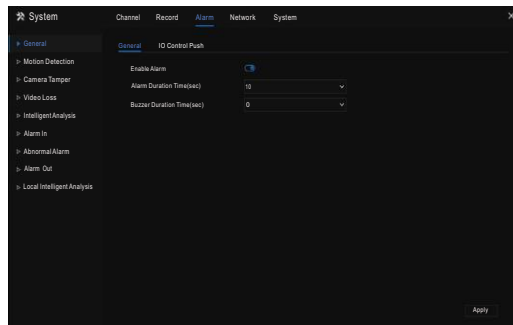

- General:** enable or disable alarm and set duration time of alarm.
- Motion Detection:** enable this function, if detection the motion actions, it will alarm.
- Event actions:** contain buzzer, alarm out, push message to App, pop-up message to monitor, send E-mail and post recording (after enabling, choose the recording time from drop list.)
- Area:** set motion detection area. Press left button and drag the cursor to add a detection area, and double-click an area to delete it.
- Schedule:** set schedule to enable or disable motion detection alarm. There are three methods to set, click the double arrows button to choose all day. The second, click and drag the cursor to select periods. The third, click one by one.
- Video Loss, Intelligent Analysis** are same settings as motion detection.
- Alarm In/Alarm Out:** settings for I/O alarming.
- Abnormal Alarm** can tick disk error, IP conflict, network disconnected.
- Local Intelligent Analysis:** set up to 4 channels intelligent analysis alarm. Choose the channel and apply, the XVR will reboot, then set the parameters of intelligent analysis.

5.4 Network

Network settings contain Network, 802.1X, DDNS, E-mail, Port Mapping, P2P, IP Filter, SNMP, 3G/4G, PPPoE, Network Traffic and Platform Access, as shown in figure 5-3. Maybe some models have more functions, please refer to actual products.

Figure 5-3 Network

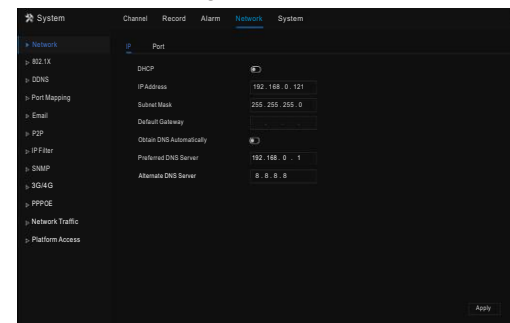

- Network, 802.1X, DDNS, and SNMP** interface to set network parameters.
- Email:** set Emails for sending and receiving alarm messages and password retrieval message.
- Port Mapping:** set the ports for remote accessing.
- P2P:** add XVR into device list of App by accessing the QR code.
- IP Filter:** settings for creating black list or white list.
- 3G/4G:** use 3G/4G modem to plug to XVR provide the network.
- PPPoE:** point to point network to access XVR directly.
- Network Traffic:** view the speed of transiting and receiving data, view the status of LAN.
- Platform Access:** enable to set the parameters of platform access, so that the XVR can be connected to platform system.

5.5 System

System settings contain Information, General, User, Security Center, Auto Sequence, Logs, Maintenance and Auto Reboot, as shown in Figure 5-4.

Figure 5-4 System

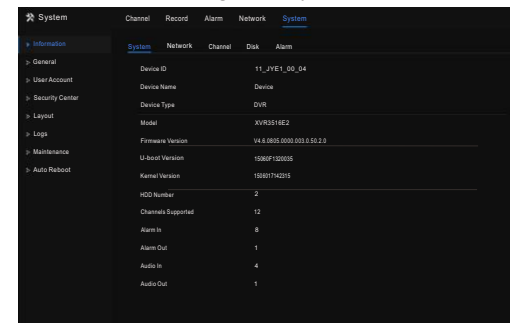

- General:** include system, date and time, time zone, DST, sync camera time.
- User Account:** add user, set advance setting(auto login, password double authentication, boot wizard) and App Verification(add whitelist to be allowed which are added to App).
- Security Center:** modify the password, pattern unlock, secure Email, Secure question.
- Layout:** set new layout to view live videos of channels. Set CVBS offset.
- Logs:** shows operating and alarm log, user can export logs if an USB disk is plugged in.
- Maintenance:** include shutdown, reboot, exit system, reset, import configuration, export configuration and update.
- Auto Reboot:** enable this function to make device restart periodically.

5.6 Live Video

Live video page is displayed after starting the XVR by default, as shown in figure 5-5.

Figure 5-5 Live video



6 Mobile Client

Search for "InView Pro4" in App Store or Google Play to download and install the mobile client. Use the App to scan the QR code on the back board of XVR, or in P2P settings page in XVR user interface. Then input the password of the XVR to add the XVR into the device list of the App. User can manage the device through mobile client.

Figure 6-1 P2P

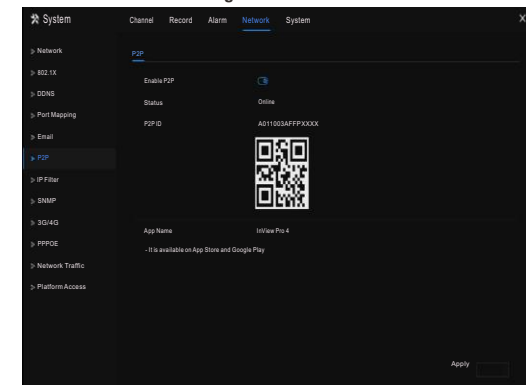

7 Web Accessing

The XVR also can be accessed in a Web browser. Open a web browser like Chrome 45 and enter the IP address of device (The default IP address is 192.168.0.121) in the address box, and press **Enter**. The login page is displayed as shown in figure 7-1.

Figure 7-1 Login

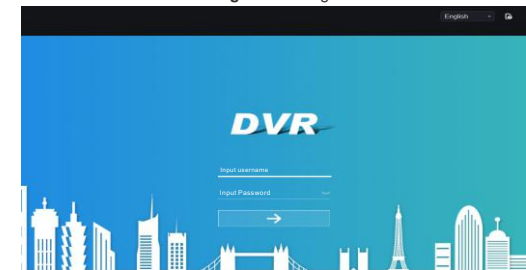

NOTE

The user name and password are same as in the UI interface.